

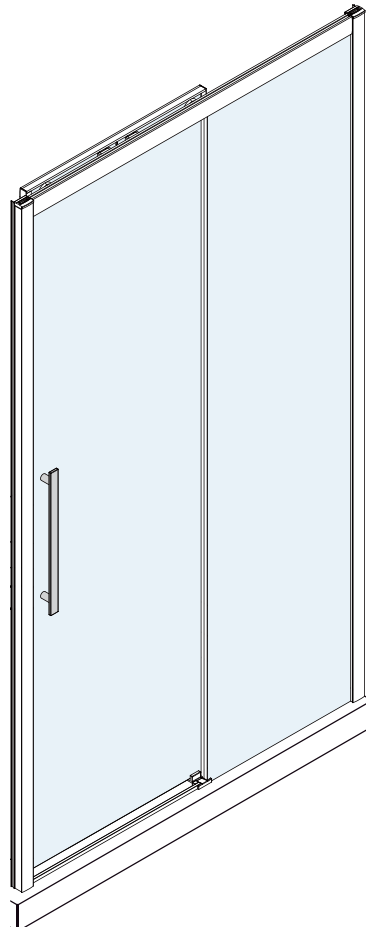

INSTALLATION MANUAL

CONCEALED SOFT-CLOSING SHOWER DOOR



Left hand door installation shown



Questions, problems, missing parts?

Before returning to your retailer, call our customer service department at 1-800-288-4002, 9 a.m. - 8 p.m., EST, Monday - Friday.

Jacuzzi items

60" x 76" - SD60826-BN / SD60827-CH / SD60817-MB

60" x 59" - SD59826-BN / SD59827-CH / SD59817-MB

48" x 76" - SD48826-BN / SD48827-CH / SD48817-MB



Important:

Jacuzzi Luxury Bath reserves the right to alter, modify or redesign products at any time without prior notice. Visit Jacuzzi.com for the latest version of installation manuals and warranty information.

Please inspect the product immediately upon receipt for freight damage, missing packs/parts, or manufacturing defect. Damage reported post delivery will not be responsibility of Jacuzzi Luxury Bath.

Read complete instructions before beginning installation. Remove the unit carefully from the carton. Retain the shipping carton until satisfactory inspection of the product has been made. Lay out and identify all parts using the installation instructions as reference. Inspect the carton for small hardware bags that tend to fall to the bottom of the carton. Handle the glass panels carefully and protect the edges. Safety tempered glass is very resistant to breakage, but it can be broken by banging the edges against a hard surface; also, it cannot be re-worked. Do not remove any protective devices until you are ready to install the glass panels as the sharp corners of the panels can damage tile and floor surfaces. Wear safety glasses whenever drilling or cutting. When drilling holes in ceramic tile or marble, use a center punch and hammer to carefully break the surface glaze so the drill can start without skidding.

This shower door can be installed with an entry to the left or to the right; also, these instructions show the installation for shower doors, but the same steps apply for bathtub doors.

Please consult with your local building codes if you have questions about installation compliance standards. These codes vary by location; Jacuzzi Luxury Bath is not responsible for local code compliance for the installation project and will not accept returns or claims associated with it.

Ensure that all surfaces are leveled, solid and will support the weight of the product that is marked on the packaging. Ensure also that the walls are at right angles. Irregular surface levels, improper angles of side walls or radius corners may result in serious problems during installation. This shower door allows for some adjustments and may include drilling during the installation process.

The shower door requires at least a 2 ¾" flat threshold space for installation. It may also require some drilling into the threshold of the shower base or floor.



Aftercare instructions

After use, your shower door should be cleaned with soap and water. This is particularly important in areas with hard water where insoluble lime salts may be deposited and allowed to build up. This door has been coated on both sides of the glass to reduce build up for ease of maintenance.

Cleaners of a gritty or abrasive nature should not be used. Care should be taken to avoid contact with strong chemicals such as organic solvents and strippers.

Please keep instructions for aftercare and customer service details.

Tools required (not supplied)

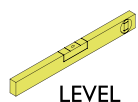

LEVEL



SILICONE CAULK
MILDEW RESISTANT
RECOMMENDED



MEASURING
TAPE

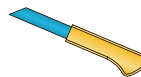

KNIFE



DRILL



PAINTER'S
TAPE



HAMMER



WRENCH



M4 & M5
SCREWDRIVER

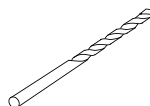

6MM
DRILL BIT

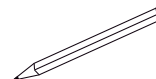

PENCIL

*Masonry drill bit may be required for tile and ceramic installations.

It is recommended to verify that the correct door size will be installed by measuring the opening where the door will be installed and comparing it with the size labeled in the packaging. Cover the drain on the shower base in case small parts land near it.

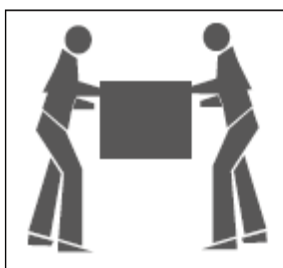

**WARNING: THIS PRODUCT IS HEAVY AND
MAY REQUIRE TWO PEOPLE TO INSTALL**

FOR REFERENCE:

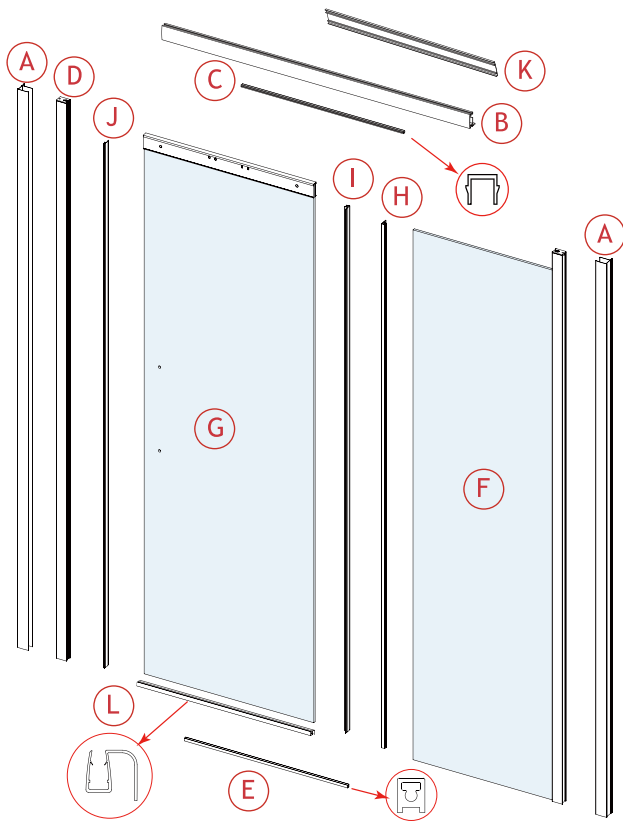

Item		Quant.	Item		Quant.
M		1 Pc	T		6 Pc
N		4 Pc	U		6 Pc
O		1 Pc	V		6 Pc
P		4 Pc	W		1R+1L Pc
Q		1R+1L Pc	X		2 Pc
R		2 Pc	Y		1 Pc
S		6 Pc	Z		1 Pc
			a		1R+1L Pc

For models:











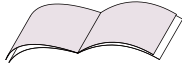



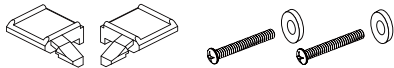

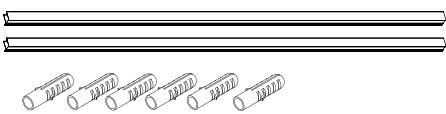

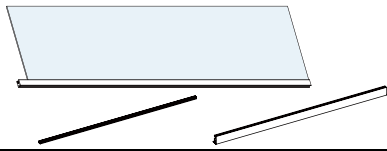

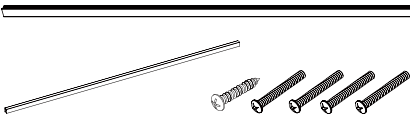

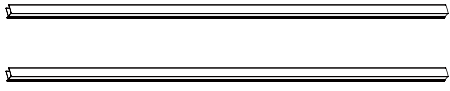
SD60826-BN / SD60827-CH / SD60817-MB
 SD59826-BN / SD59827-CH / SD59817-MB
 SD48826-BN / SD48827-CH / SD48817-MB

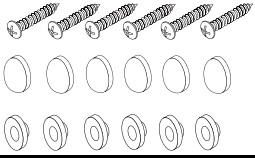
A: 2xWall jambs
 B: 1xTop rail
 C: 1xTop rail cover
 D: 1xSide jamb
 E: 1xDoor threshold
 F: 1xFixed panel
 G: 1xSliding glass panel
 H: 1xFixed panel seal
 I: 1xDoor seal strip

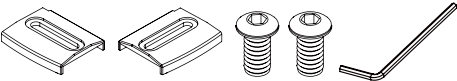
J: 1xDoor seal strip
 K: 1xTop door cover
 L: 1xBottom seal strip
 M: 1xHandle
 N: 4xScrew 5x25
 O: 1xScrew 4x20
 P: 4xScrew 4x25
 Q: 2xDamper trigger
 R: 2xRoller

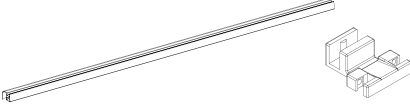
S: 6x Wall mount anchor
 T: 6xScrew cap
 U: 6xScrew washer
 V: 6xScrew 4x30
 W: 2xTop cap
 X: 2xScrew 5x12
 Y: 1xAllen key
 Z: 1xCenter guide
 a: 2xTop rail end cap

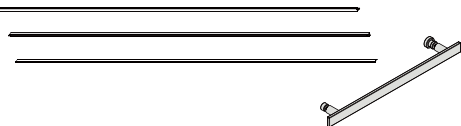
BOX CONTENTS:

STEP 1	1X Installation Manual		
	G: 1x Sliding glass panel R: 2x Roller		
	Q: 2x Damper trigger P: 4x Screw 4x25		
STEP 2	A: 2x Wall jambs S: 6x Wall mount anchor		
STEP 3	B: 1x Top rail C: 1x Top rail cover F: 1x Fixed panel		
	D: 1x Side jamb E: 1x Door threshold O: 1x Screw 4x20 N: 4x Screw 5x25		
STEP 4	A: 2x Wall jambs		
STEP 5	T: 6x Screw cap U: 6x Screw washer V: 6x Screw 4x30		
STEP 6	W: 2x Top cap X: 2x Screw 5x12 Y: 1x Allen key		
STEP 7	L: 1x Bottom seal strip Z: 1x Center guide		
STEP 8	H: 1x Fixed panel seal I: 1x Door seal strip J: 1x Door seal strip M: 1x Handle		
STEP 10	K: 1x Top door cover a: 2x Top rail end cap		



Concealed Roller Door Cutting Instructions

(SD48XXX, SD59XXX, SD60XXX)

This modification is only required when the shower alcove measures less than 57-7/8"

1. Locate the shower door top rail (B), bottom door threshold (E) and top rail cover (C).
2. The top rail can be cut on the left or right.
3. Remove the slow close mechanism that is inside the top rail by removing top and bottom screws.
4. Cut 3/4" off the top rail using an appropriate saw.
5. Replace the slow close mechanism inside the top rail with the top and bottom screws.
6. Make a small notch to the top rail end that was cut using a small file. Notch the area that the arrow is pointing to.
7. Cut 3/4" off the top rail cover and bottom door threshold. Cut the end off the bottom door threshold that is not screwed to the side rail.
8. Once all the cutting has been completed, follow the instructions to complete the installation.

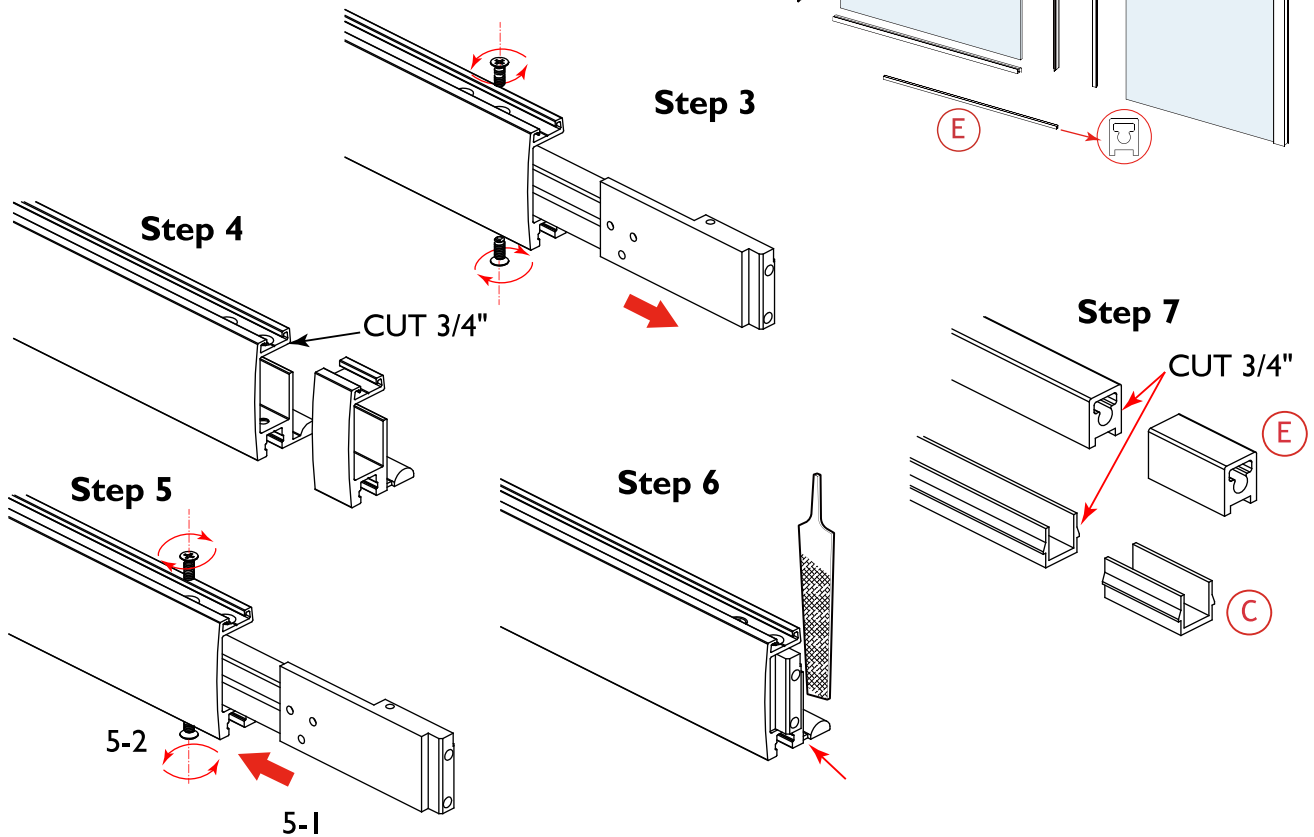
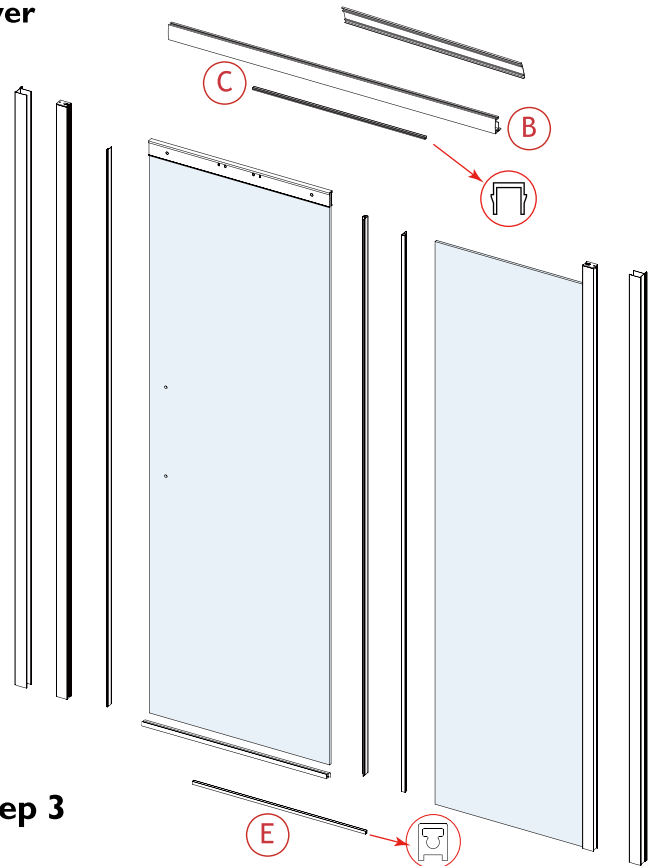

INSTALLATION STEPS:

Step 1: Install the rollers on sliding glass panel

NOTE: If entry will be on the left, the holes for the handle will be on the left and the panel will open to the right. If entry will be on the right, the holes for the handle on the panel will be on the right and the panel will open to the left.

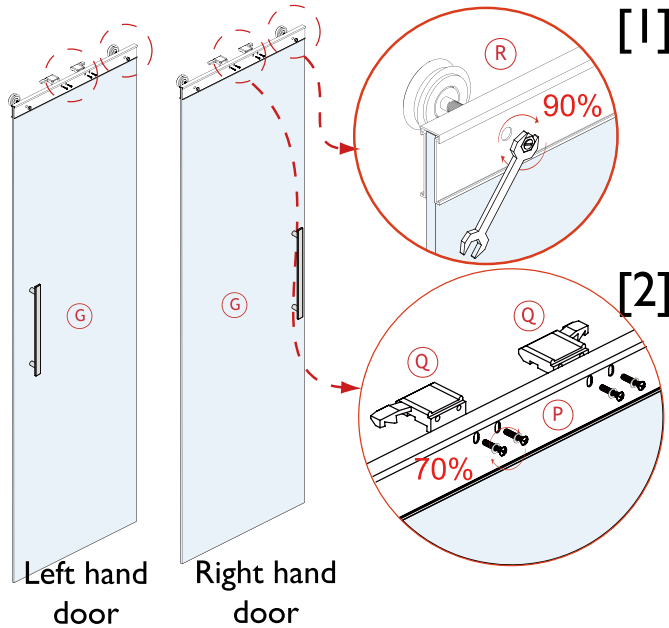

NOTE: Do not fully tighten bolt, only to about 90%

NOTE: Do not fully tighten screws, only to about 70%

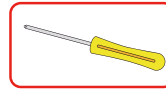

Step 2: Pre-drill holes for wall jambs

NOTE: Temporary hold in place with painter's tape

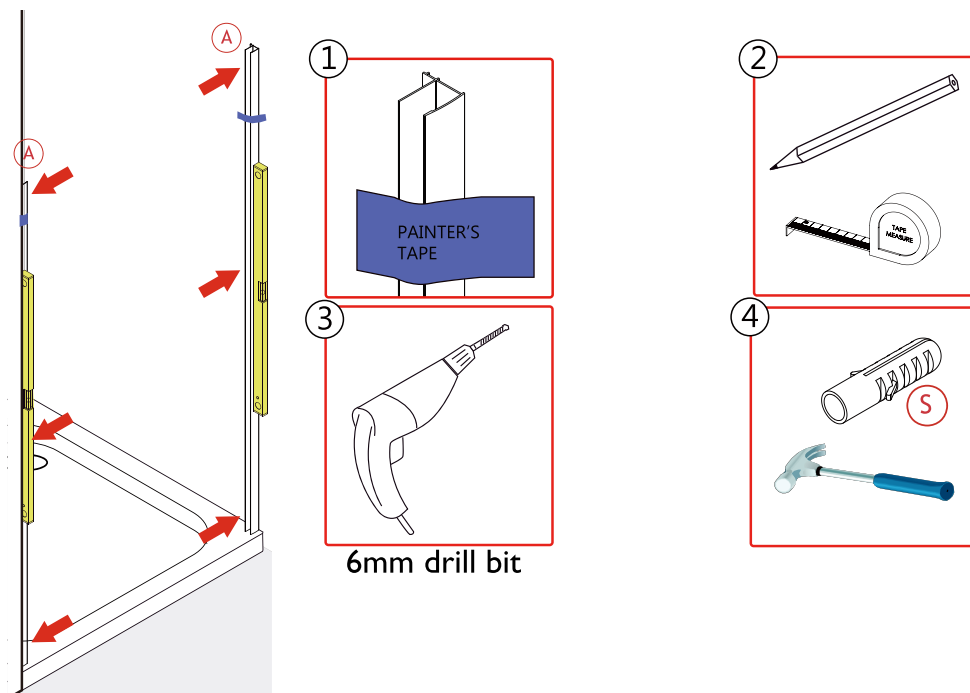

6mm drill bit

Step 3: Assemble the frame around the fixed panel

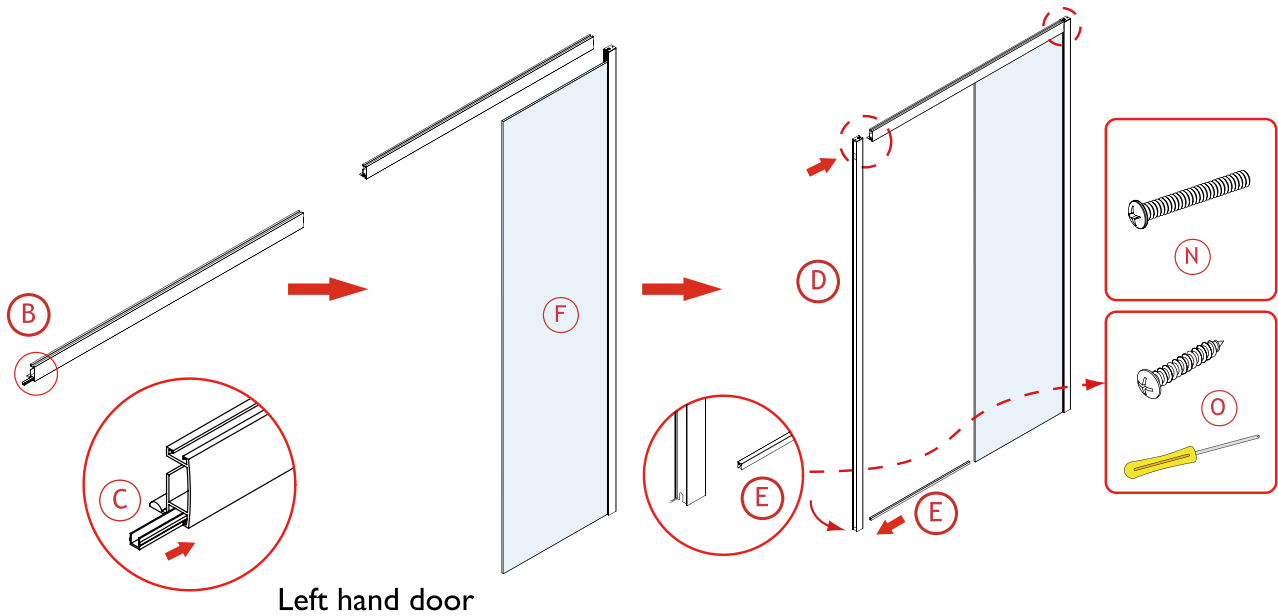

Step 4: Attach the fixed panel frame into the wall jambs

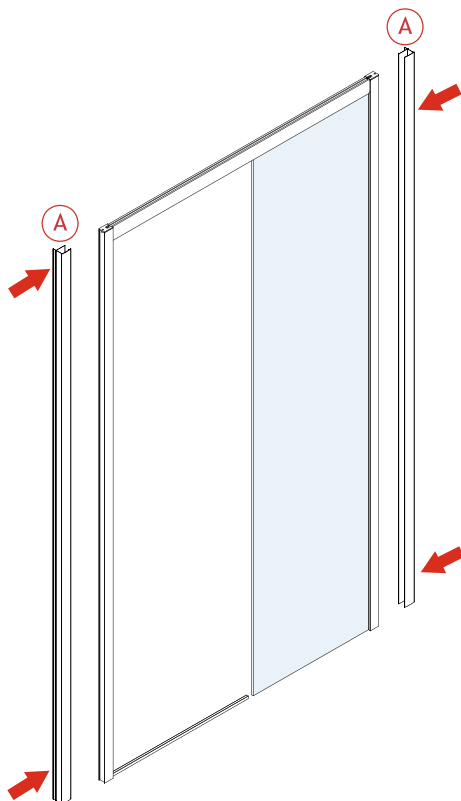

Step 5: Secure the fixed panel frame and wall jambs into the alcove

Ensure correct orientation of bottom spacer.

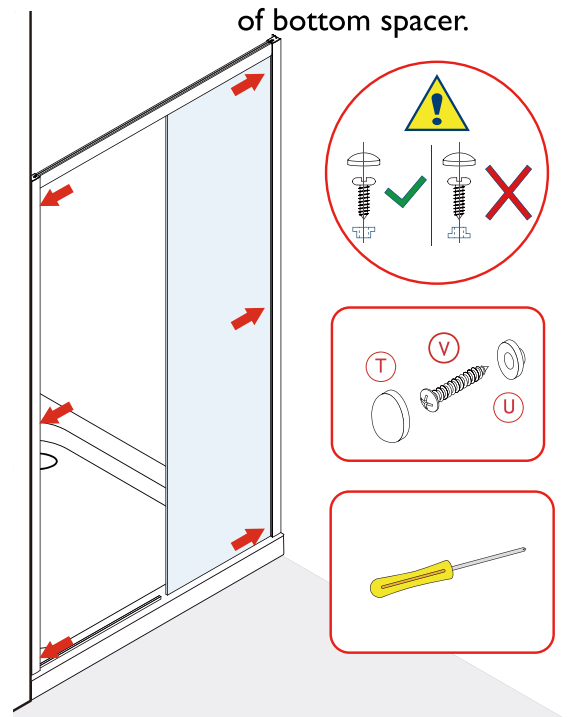

Step 6: Ensure fixed panel frame is level and attach top caps

Note: Ensure the top rail is centered between walls by inspecting that the space between wall jamb and frame is equal on both ends.

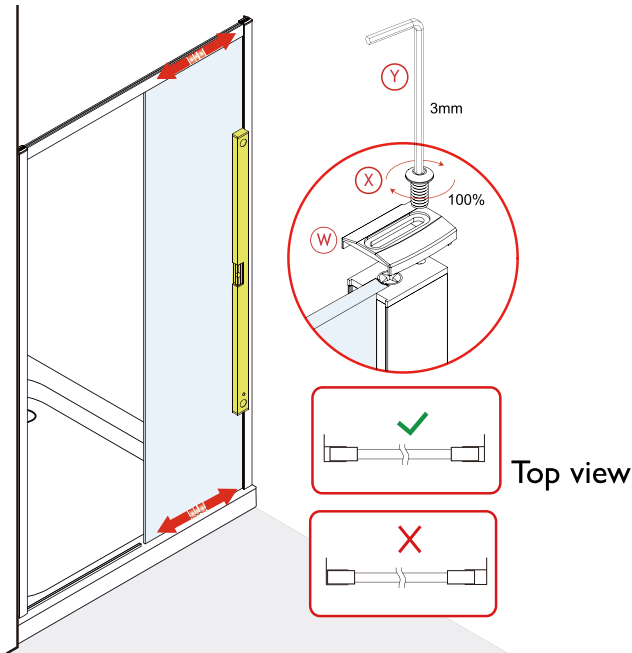

Step 7: Install bottom guide and sliding door

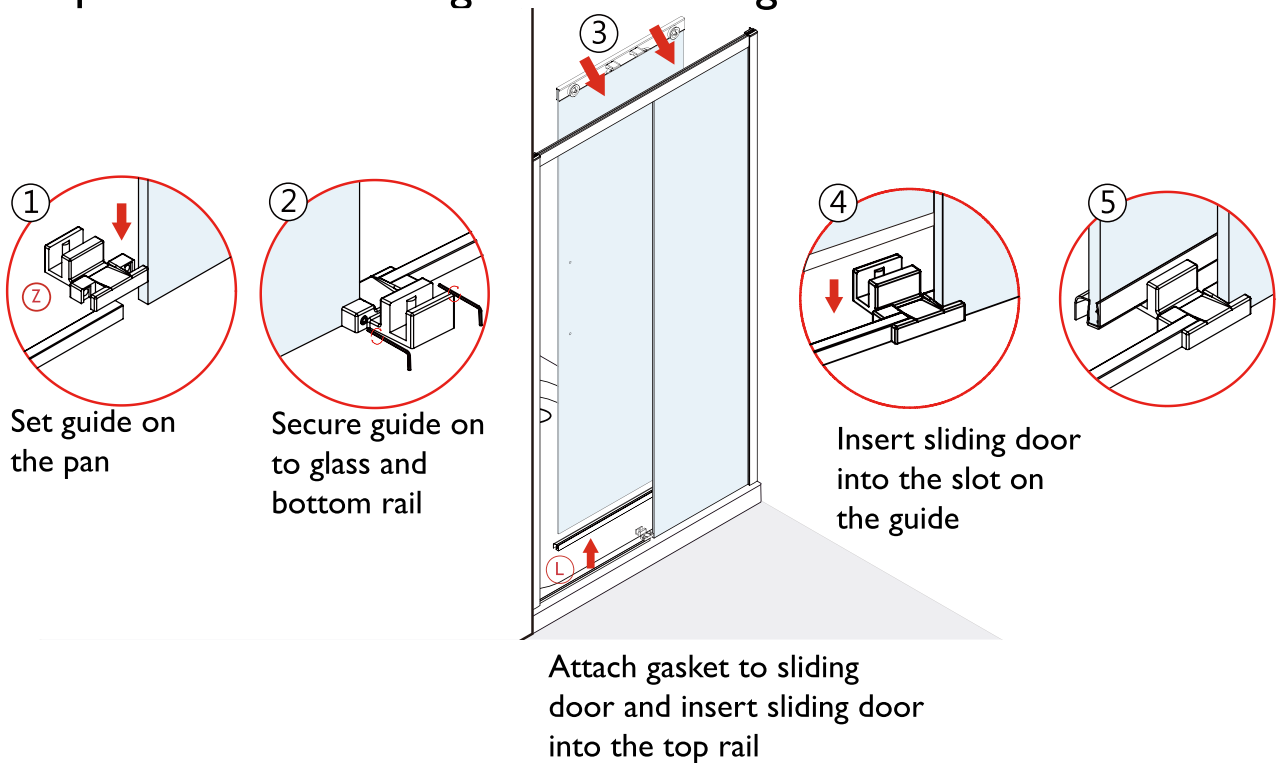

Step 8: Install gaskets and handle

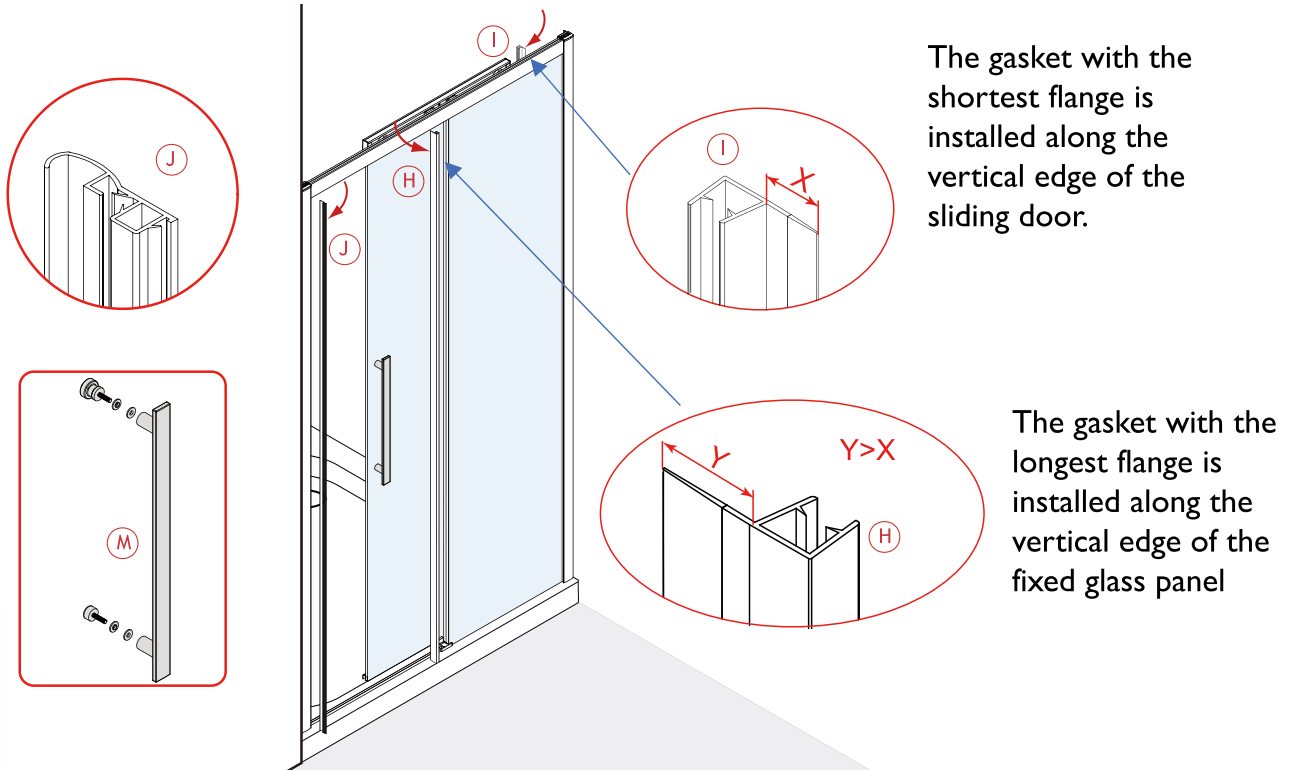

Step 9: Adjust rollers and soft-closing mechanism

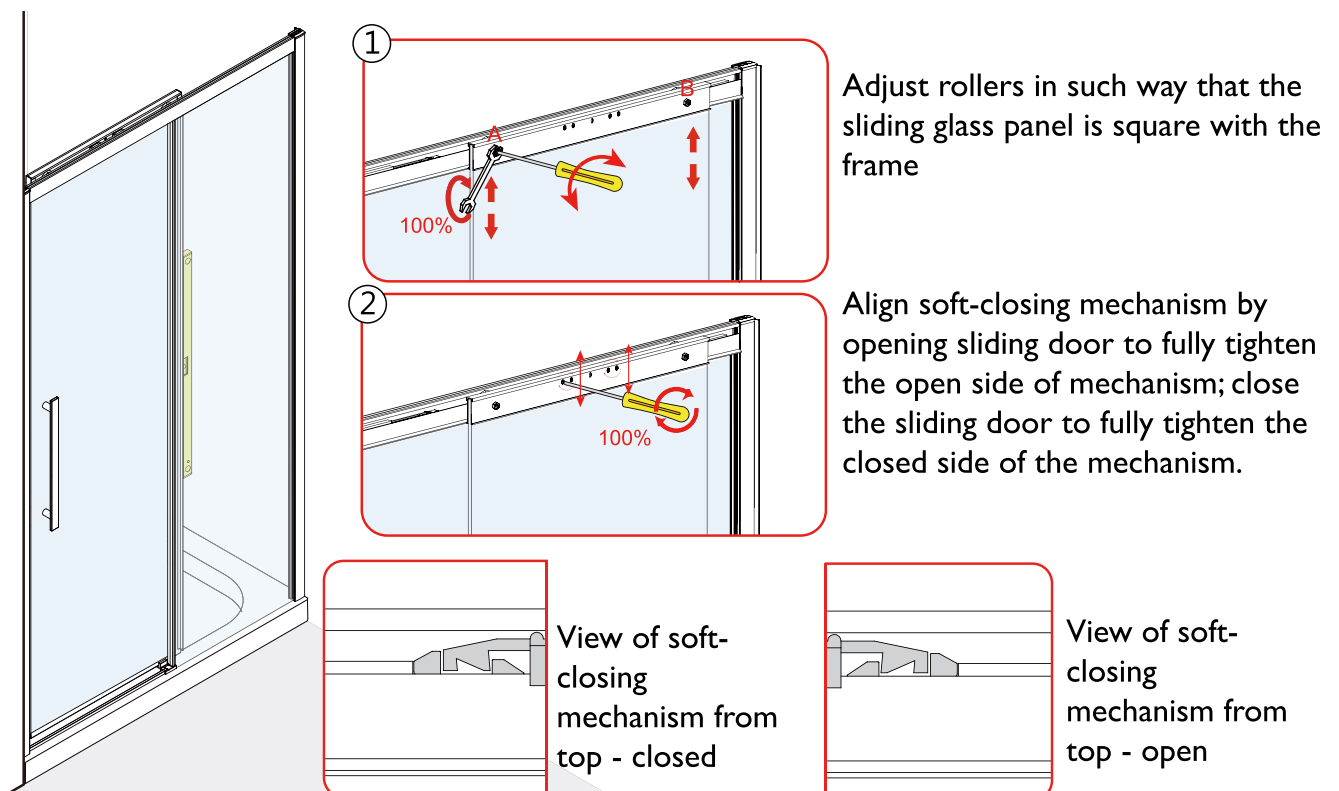

Step 10: Attach top rail cover and anti-jump mechanism

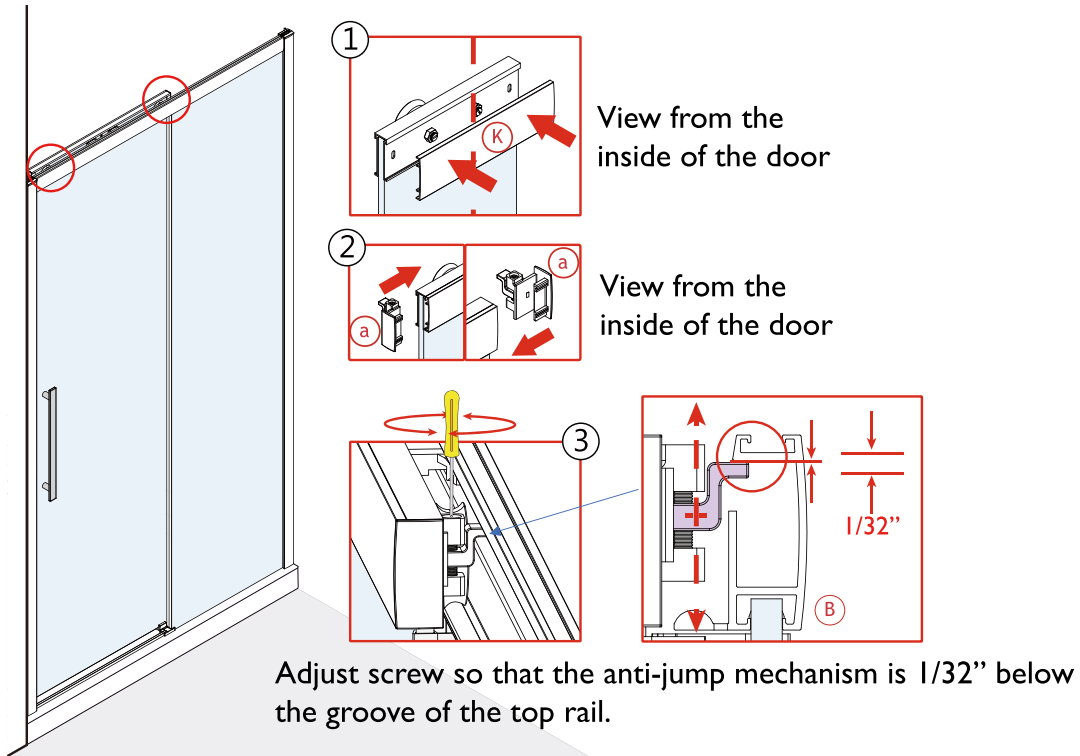

Step 11: Apply silicone on the inside and outside of the door

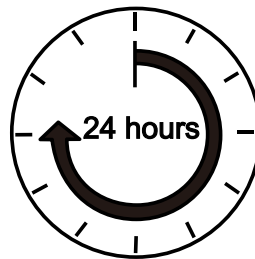
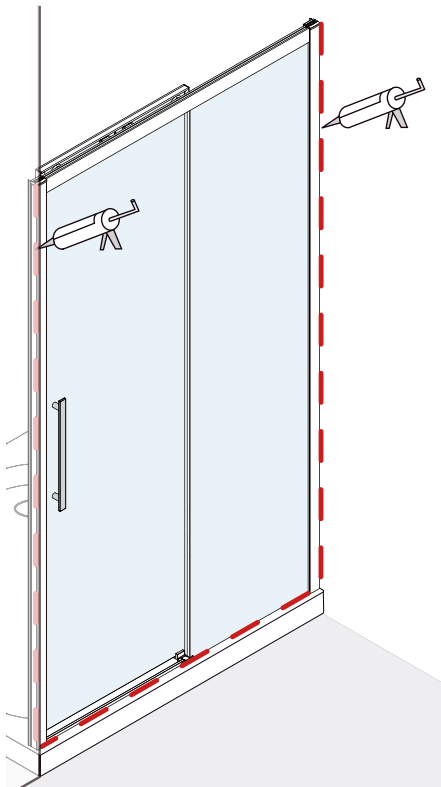

Allow 24 hours for silicone to dry before use

DO NOT USE SHOWER



One Year Limited Warranty on Jacuzzi® Branded Shower Doors

Jacuzzi Luxury Bath ("Company") offers a one year warranty to the original purchaser ("user") of a Jacuzzi® branded shower door(s) for personal or single family residential use, subject to the following terms, conditions and limitations. The Company will repair or replace, at its sole option, the shower door(s) or its component parts in accordance with the terms, conditions and limitations set forth in this limited warranty. Units in commercial use are excluded from any warranty coverage whatsoever. PLEASE READ THIS ENTIRE LIMITED WARRANTY, AS EXCLUSIONS AND CONDITIONS APPLY. All portions of the shower door(s) are warranted against defects in material and workmanship for one year from date of purchase. This warranty does not apply to any display models or to any options or accessories not specifically mentioned herein. Warranty coverage begins on the date the unit was originally purchased by the user from an authorized Jacuzzi® dealer. The warranties provided by Company do not cover labor, and are parts only warranties.

The components referenced above and coverage of this warranty are for defects in material or workmanship, and not damage caused by installation, neglect, modification, alteration, misuse, abuse, hard water conditions, optional equipment, the unit's prior usage as an operational display, defects that should have been discovered before installation, or failure to follow the instructions and warnings set forth in the owner's manual, including but not limited to cleaning of the shower door and its component parts, such as using chemicals, abrasives, acids, solvents, etc. Inspecting the unit prior to installation is the responsibility of the user, as well as the installer or building contractor who acts on behalf of the user. In the event of a problem, the unit must not be installed. The Company is not responsible for failures or damage that could have been discovered, repaired, or avoided by proper inspection and testing prior to installation. Damage occurring in transit is the responsibility of the carrier. Damage occurring to the unit during installation is the responsibility of the installer, building contractor and/or user, and damage occurring thereafter is the responsibility of the user. The distributor, dealer and user are responsible for knowing local code requirements and notifying the installing contractor of these requirements at the time of purchase. The Company is not responsible for costs to modify any product to obtain any code approval, such as city, county, or state building codes in U.S.A. or federal, municipal, provincial or other codes in Canada and Mexico. To make a claim, user must first contact Company and thereafter return any part claimed to be defective within the warranty period to Company, freight prepaid. Proof of purchase (original sales receipt) must accompany all warranty claims. Defects or damage caused by the use of other than genuine Company parts is not covered by this warranty.

IMPLIED WARRANTIES OF MERCHANTABILITY AND FITNESS FOR A PARTICULAR PURPOSE ARE DISCLAIMED ALTOGETHER OR TO THE FULLEST EXTENT ALLOWED BY LAW. This warranty takes the place of all other warranties, express or implied, in fact or at law, including implied warranties of merchantability and fitness for a particular purpose. Company reserves the right to use replacement parts that may be different from the original shower door or its component parts, including but not limited to different in appearance, configuration, performance and/or structure. No agent, dealer, distributor, service company or other party is authorized to change, modify or extend the terms of this limited warranty in any manner whatsoever. In addition, THE COMPANY WILL NOT BE RESPONSIBLE FOR INCIDENTAL OR CONSEQUENTIAL DAMAGES or losses arising from any cause including but not limited to its own negligence. This exclusion applies even if Company was advised in advance of the possibility of such damages. This limited warranty does not include labor, transportation, or other costs incurred in the removal and/or reinstallation of the original unit and/or installation of a replacement unit; any costs relating to obtaining access for repair; or loss of use damage, including loss of sales, profit or business advantage of any kind under any circumstances. Warranty coverage is provided in the United States of America, Canada and Mexico only. All replacement parts, equipment, and repairs shall assume the remaining warranty period of the part(s) replaced. The Company's warranty obligation shall be discharged upon tender of replacement or repair. The customer's refusal to accept the tender terminates the Company's warranty obligation. The liability of Company under this limited warranty, if any, shall not exceed the original amount paid for the product claimed to be defective. These disclaimers shall be equally applicable to any service provided by Company and its designated representatives.

The Company will provide the warranty service described above when the following conditions have been met: the failure is of the nature or type covered by the warranty; the user has informed an Authorized Jacuzzi Luxury Bath Service Agent or Warranty Service Department Representative of the nature of the problem during the warranty period; conclusive evidence (e.g., dated proof of purchase) is provided to the foregoing by the user proving that the failure occurred or was discovered within the warranty period; and, an authorized independent service person or Company representative has been permitted to inspect the unit during regular business hours within a reasonable time after the problem was reported by the user. To obtain warranty service, contact Company at: www.jacuzzi.com or Warranty Service Department, 14525 Monte Vista Avenue, Chino, California 91710, (800) 288-4002.

LEGAL RIGHTS: This Limited Warranty gives you specific legal rights. There are no warranties applicable to Jacuzzi® products except as expressly stated herein or as implied by applicable state and federal laws, and not excluded. You may also have other rights that vary from state to state. Some states do not allow limitations on how long an implied warranty lasts, disclaimer of certain warranties, or the exclusion or limitation of incidental damages, so some of the above limitations may not apply to you. Company will not be responsible for any statements or representations made in any form that go beyond, are broader than or are inconsistent with any authorized literature or specifications furnished by the Company.





MANUAL DE INSTALACIÓN

CANCEL DE RUEDAS OCULTAS

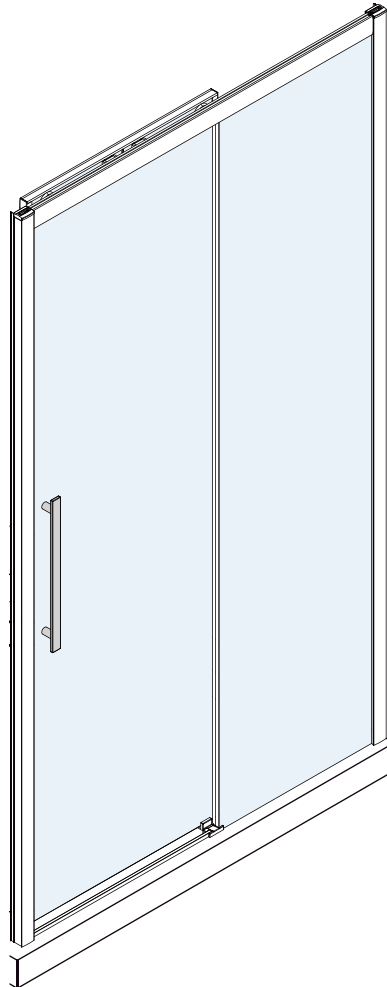

Instalación con entrada a la izquierda mostrada

¿Preguntas, problemas o partes faltantes?

Antes de regresar a su distribuidor, contáctese a nuestro departamento de servicio al cliente al 1-800-288-4002, 9 a.m. - 8 p.m., EST, Lunes - Viernes.

Para partes Jacuzzi®

60" x 76" - SD60826-BN / SD60827-CH / SD60817-MB
60" x 59" - SD59826-BN / SD59827-CH / SD59817-MB
48" x 76" - SD48826-BN / SD48827-CH / SD48817-MB



Importante:

Jacuzzi Luxury Bath se reserve el derecho de alterar, modificar o rediseñar sus productos en cualquier momento sin previa notificación. Visite www.jacuzzi.com para encontrar la versión más reciente de los manuales de instalación y documentos de garantía.

Favor de inspeccionar cuidadosamente el product en busca de daño por distribución, partes faltantes o defectos de manufactura. Reclamos por daño de distribución no son responsabilidad de Jacuzzi Luxury Bath una vez aceptado el product.

Lea cuidadosamente las instrucciones antes de instalar el product. Extraiga el product de la caja con cuidado. Mantenga la caja original hasta haber completado la inspección del product. Identifique todas las partes requeridas para la instalación. Verifique que todas las partes hayan sido extraídas de la caja, puesto que algunas de las partes más pequeñas pueden esconderse en el fondo. Maneje el vidrio con mucho cuidado y proteja las orillas. Vidrio templado es muy resistente, pero puede romperse si las orillas golpean superficies duras. Una vez dañado, el vidrio templado no puede ser reparado. No remueva los protectores hasta que esté listo para instalar el vidrio ya que las orillas del vidrio pueden dañar mosaicos y la superficie de pisos. Utilice gafas de protección cuando corte o taladre materiales. Si va a taladrar en mosaico o cantera, utilice una guía cental y un martillo para romper la primer capa y evitar que el taladro se deslice.

Este cancel puede ser instalado con entrada a la izquierda o derecho. Las instrucciones siguientes muestran la instalación para un cancel de baño, pero los mismos pasos deben seguirse para instalar un cancel de ducha.

Consulte con los códigos de instalaciones locales en su área. Dichos códigos varían por region. Jacuzzi Luxury Bath no se aceptará devoluciones causadas por quejas asociadas a faltas a los códigos de instalación locales.

Asegúrese que todas las superficies estén niveladas, sean sólidas y puedan soportar el peso del product según lo indicado en la caja. Las paredes deben tener ángulos rectos. Superficies irregulares causarán problemas de instalación. Este cancel permite ciertos ajustes y puede requerir taladrar superficies.

La instalación de este cancel requiere al menos 2 ¾" de superficie plana en la base. Puede requerir taladrar en la base.



Instrucciones sobre el cuidado

Lave el cancel con agua y jabón después de cada uso. Esto es particularmente importante en áreas de agua dura, donde alto grado de depósitos de sal pueden acumularse. Este cancel ha sido tratada con agentes que reducen dichos depósitos para facilitar su aseo y cuidado.

No utilice limpiadores abrasivos. Evite el uso de químicos Fuertes tales como solvents orgánicos. Mantenga estas instrucciones como referencia future.

Herramientas requeridas (no incluidas)

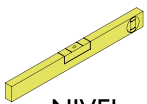

NIVEL

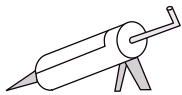

SILICÓN RESISTENTE
AL MOHO



CINTA DE
MEDIR

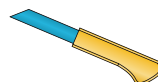

NAVAJA



TALADRO



CINTA DE
PINTOR



MARTILLO



LLAVE



DESARMADORES
M4 Y M5

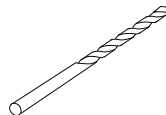

6MM & 3.2MM
BROCAS*



LÁPIZ

*Taladro de albañilería puede ser requerido para instalaciones en mosaico y cerámica.

Se recomienda verificar que el cancel es del tamaño correcto para el espacio donde será instalado. Mida el espacio y compárelo con las dimensiones del cancel señaladas en la caja. Cubra la rejilla de drenaje para evitar que partes o basura la obstruyan.

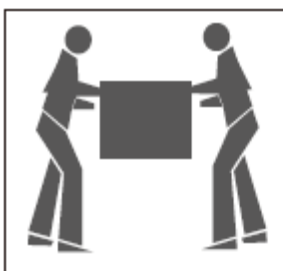

ADVERTENCIA: ESTE PRODUCTO ES PESADO Y PUEDE
REQUERIR DE DOS PERSONAS PARA INSTALARSE



COMO REFERENCIA:

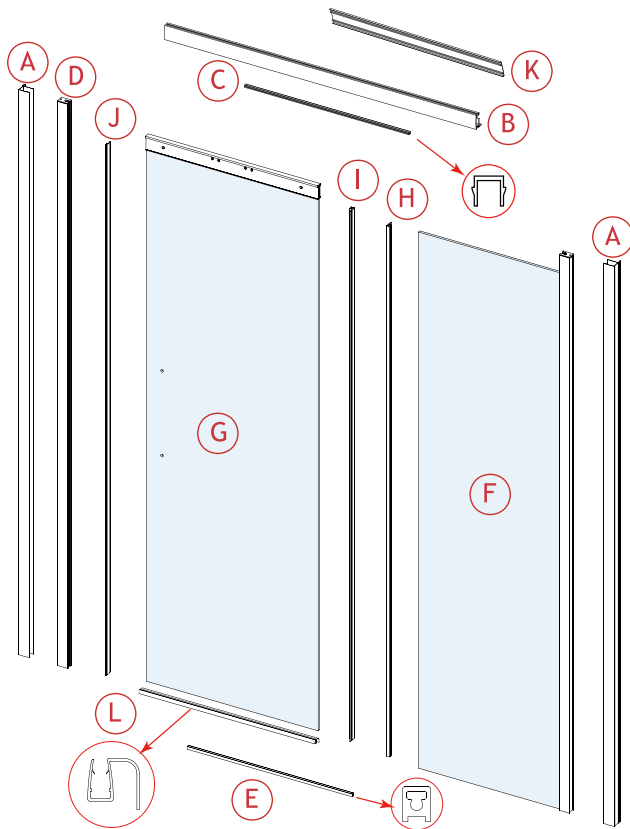

Item		Quant.	Item		Quant.
(M)		1 Pc	(T)		6 Pc
(N)		4 Pc	(U)		6 Pc
(O)		1 Pc	(V)		6 Pc
(P)		4 Pc	(W)		1R+1L Pc
(Q)		1R+1L Pc	(X)		2 Pc
(R)		2 Pc	(Y)		1 Pc
(S)		6 Pc	(Z)		1 Pc
			(a)		1R+1L Pc

Para modelos:











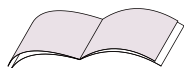

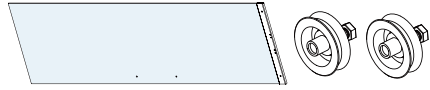

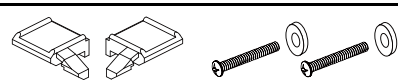

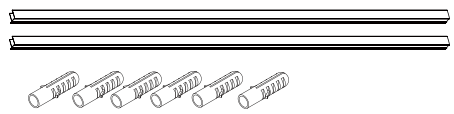

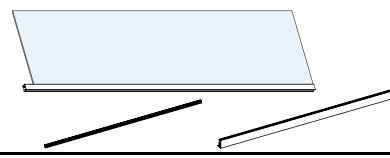

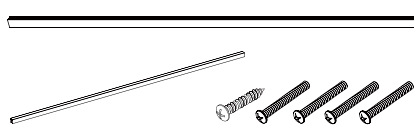

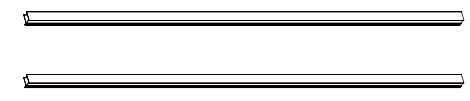
SD60826-BN / SD60827-CH / SD60817-MB
 SD59826-BN / SD59827-CH / SD59817-MB
 SD48826-BN / SD48827-CH / SD48817-MB

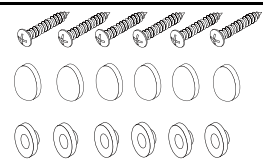
A: 2xWall jambs
 B: 1xTop rail
 C: 1xTop rail cover
 D: 1xSide jamb
 E: 1xDoor threshold
 F: 1xFixed panel
 G: 1xSliding glass panel
 H: 1xFixed panel seal
 I: 1xDoor seal strip

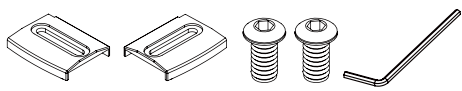
J: 1xDoor seal strip
 K: 1xTop door cover
 L: 1xBottom seal strip
 M: 1xHandle
 N: 4xScrew 5x25
 O: 1xScrew 4x20
 P: 4xScrew 4x25
 Q: 2xDamper trigger
 R: 2xRoller

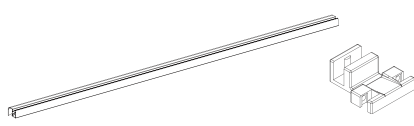
S: 6x Wall mount anchor
 T: 6xScrew cap
 U: 6xScrew washer
 V: 6xScrew 4x30
 W: 2xTop cap
 X: 2xScrew 5x12
 Y: 1xAllen key
 Z: 1xCenter guide
 a: 2xTop rail end cap

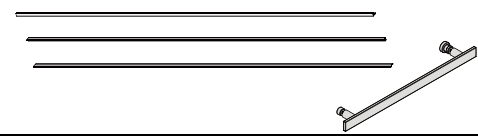
CONTENIDO DE LA CAJA:

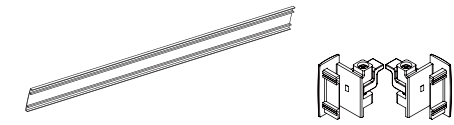
PASO 1	1XInstallation Manual		
	G: 1xSliding glass panel R: 2xRoller		
	Q: 2xDamper trigger P: 4xScrew 4x25		
PASO 2	A: 2xWall jambs S: 6x Wall mount anchor		
PASO 3	B: 1xTop rail C: 1xTop rail cover F: 1xFixed panel		
	D: 1xSide jamb E: 1xDoor threshold O: 1xScrew 4x20 N: 4xScrew 5x25		
PASO 4	A: 2xWall jambs		
PASO 5	T: 6xScrew cap U: 6xScrew washer V: 6xScrew 4x30		
PASO 6	W: 2xTop cap X: 2xScrew 5x12 Y: 1xAllen key		
PASO 7	L: 1xBottom seal strip Z: 1xCenter guide		
PASO 8	H: 1xFixed panel seal I: 1xDoor seal strip J: 1xDoor seal strip M: 1xHandle		
PASO 10	K: 1xTop door cover a: 2xTop rail end cap		

Instrucciones para cortar Cancel de Ruedas Ocultas

(SD48XXX, SD59XXX, SD60XXX)

Esta modificación es requerida cuando el espacio de pared a pared es menor a 57 7/8"

1. Ubique el riel superior (B), la guía inferior (E) y la cubierta del riel superior (C).
2. El riel superior puede cortarse del lado derecho o izquierdo.
3. Retire el mecanismo de cierre lento ubicado dentro del riel desatornillando los tornillos superiores e inferiores.
4. Corte 3/4" del riel superior usando un serrucho apropiado.
5. Vuelva a insertar el mecanismo de cierre lento dentro del riel superior y atornille los tornillos.
6. Redondee el riel superior usando una lija. Lije el área señalada en la flecha.
7. Corte 3/4" de la cubierta del riel superior y de la guía inferior del lado opuesto al que se atornilla al marco lateral.
8. Una vez que haya completado estos pasos, continúe con la instalación del cancel.

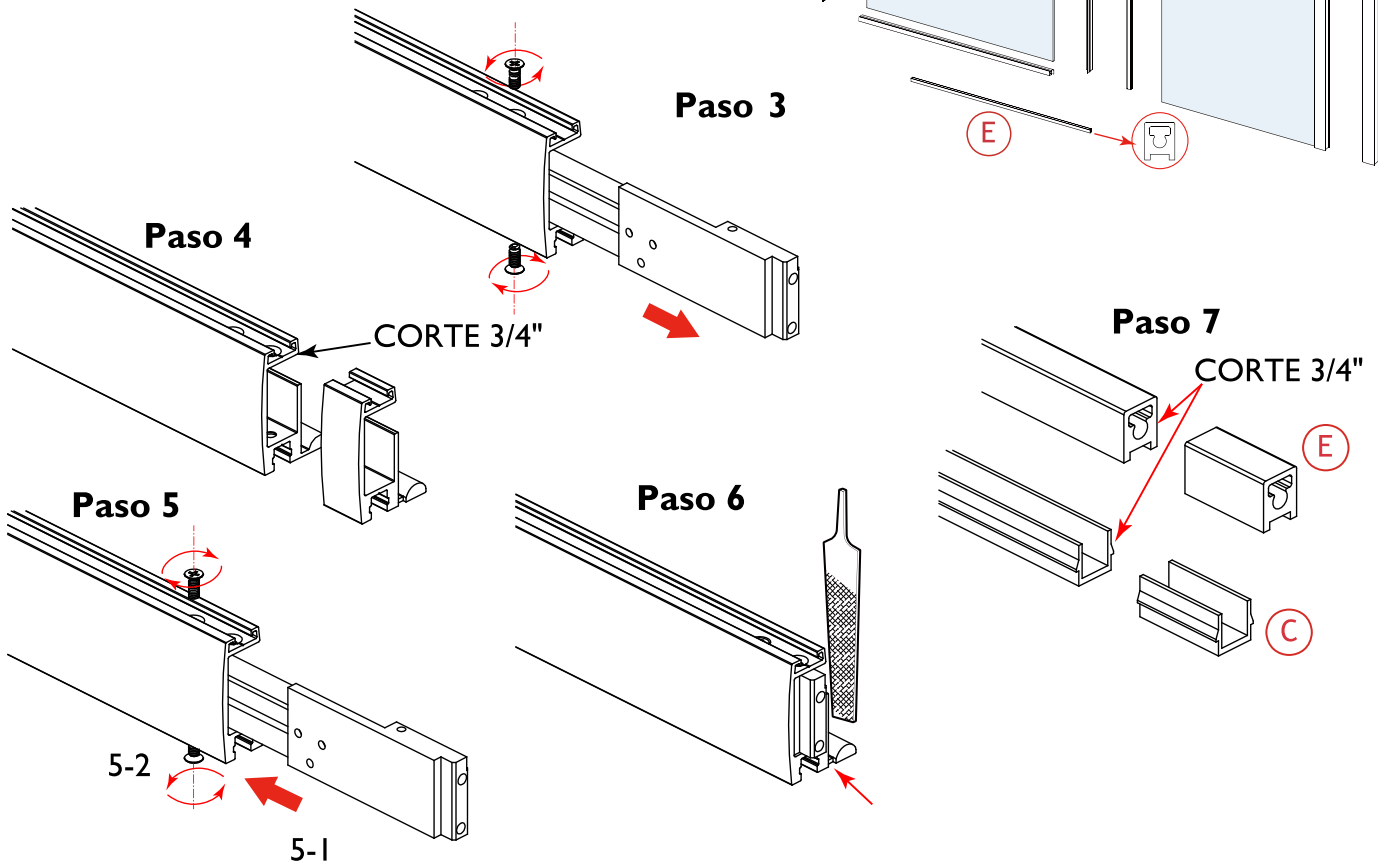
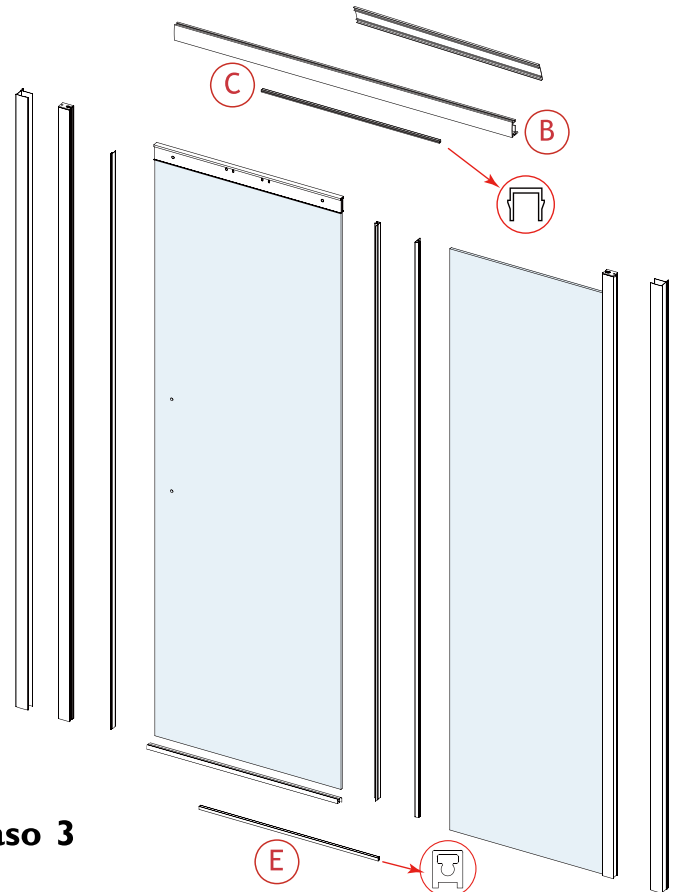

PASOS DE INSTALACIÓN:

Paso 1: Instale las ruedas en el vidrio deslizante

NOTA: Si la entrada será a la izquierda, los orificios para la manilla estará a la izquierda, para abrir hacia la derecha; viceversa si la entrada será a la derecha.

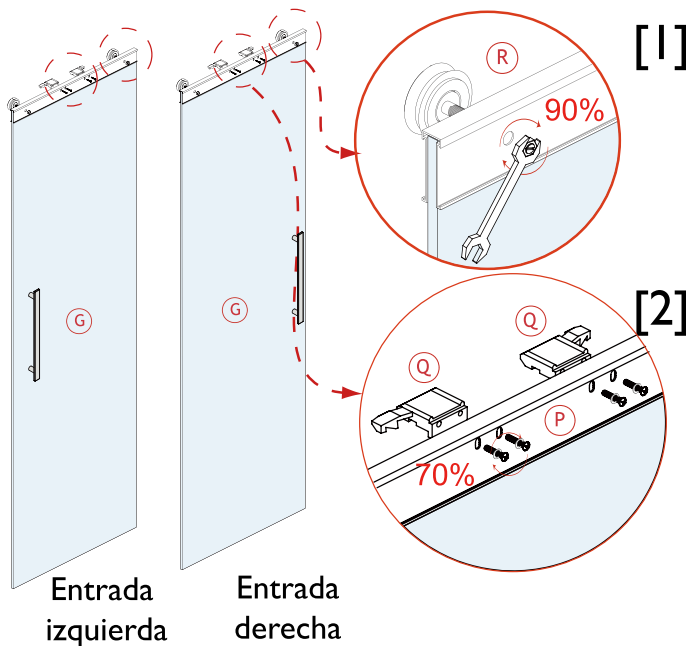

NOTA: No apretar por completo, sólo hasta un 90%

NOTA: No apretar por completo, sólo hasta un 70%

Paso 2: Perfore y señale los marcos laterales

NOTA: Sujete con cinta de pintor

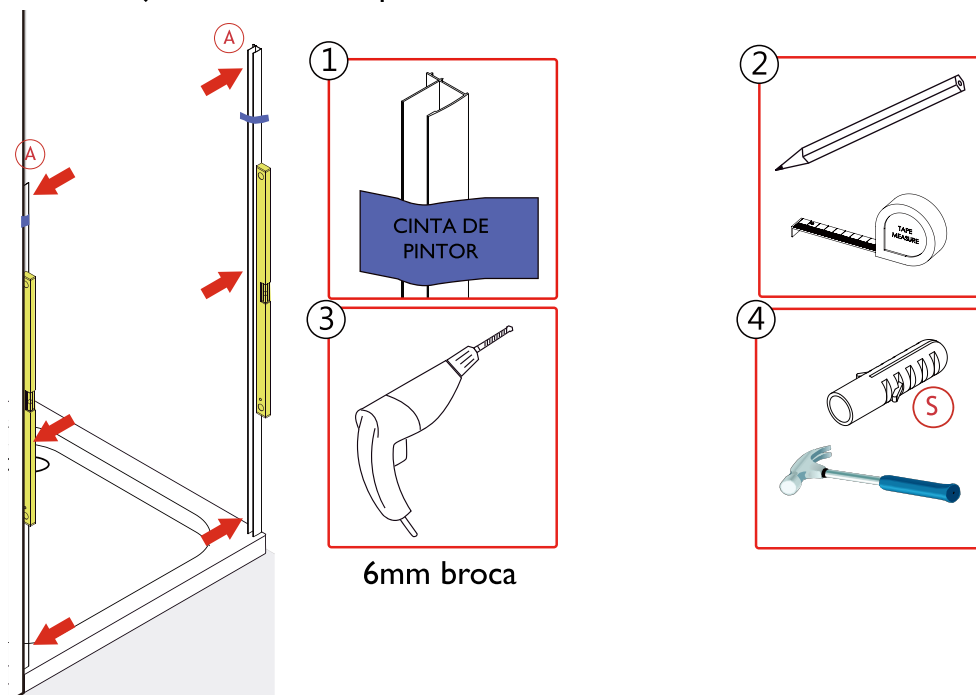

6mm broca

Paso 3: Instale el marco alrededor del vidrio fijo

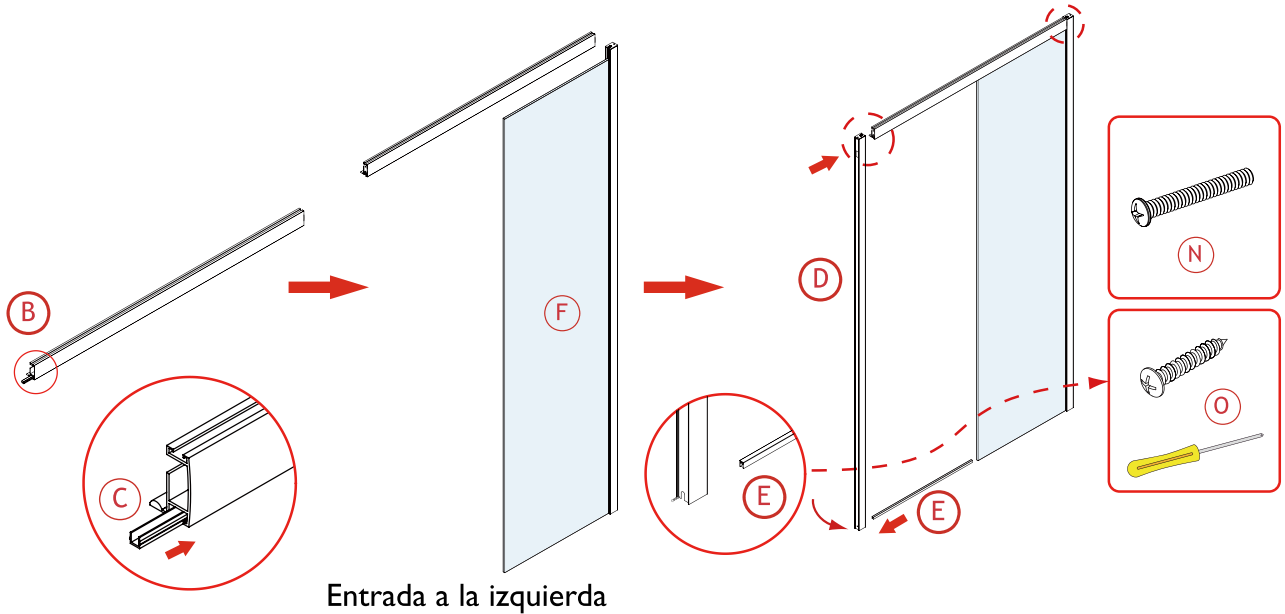

Paso 4: Ensamble el marco de vidrio fijo con los marcos laterales

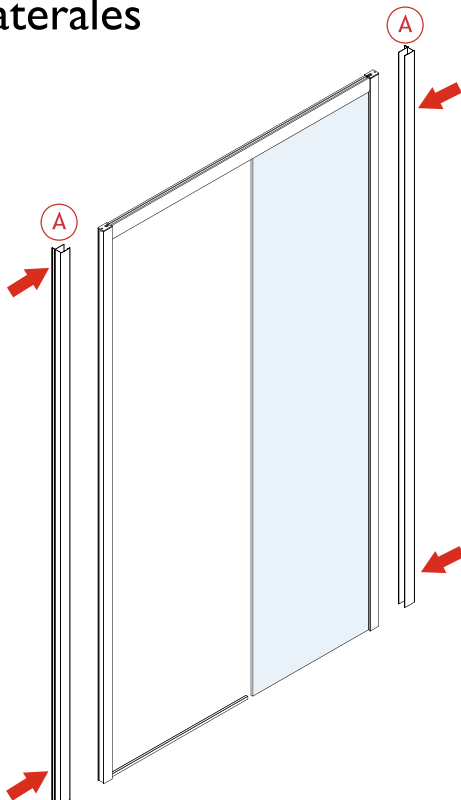

Paso 5: Instale el marco de cancel completo a la pared usando los orificios previamente perforados y señalados

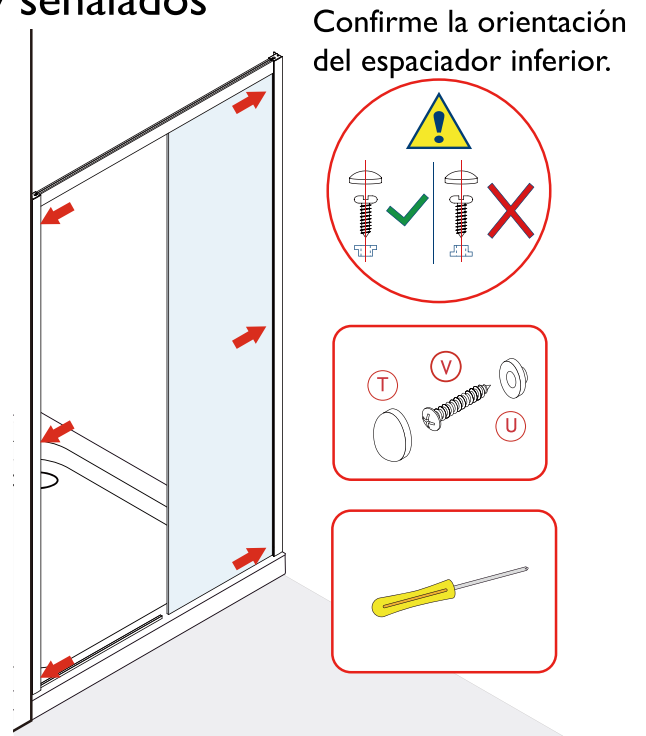

Paso 6: Nivele el marco con el vidrio fijo y adhiera los tapones superiores.

Nota: Verifique que el riel superior esté centrado con respecto a las paredes inspeccionando que el espacio entre los marcos laterals sea igual en ambos lados.

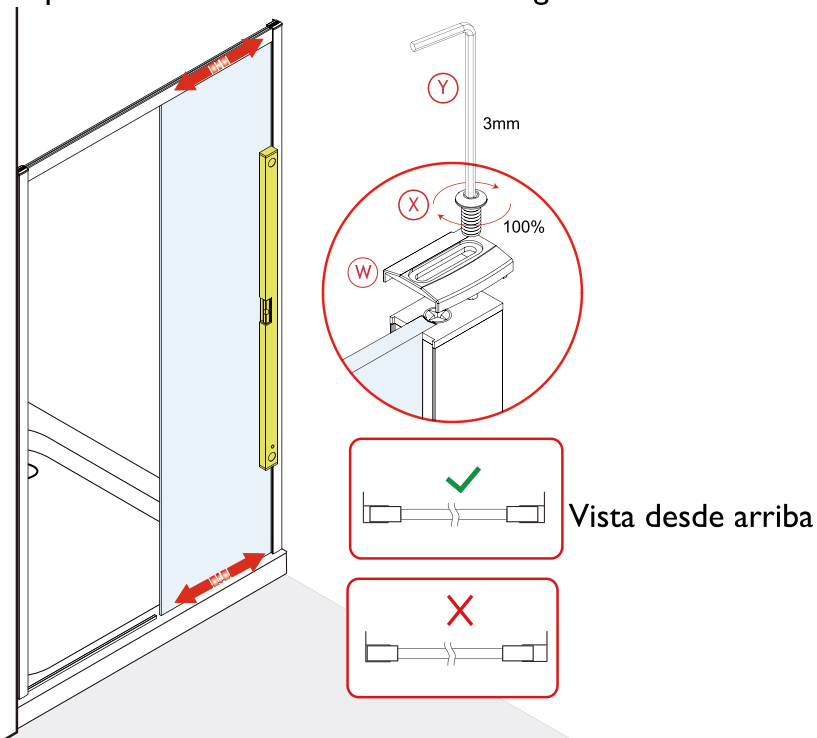

Paso 7: Instale la guía inferior y el vidrio deslizante

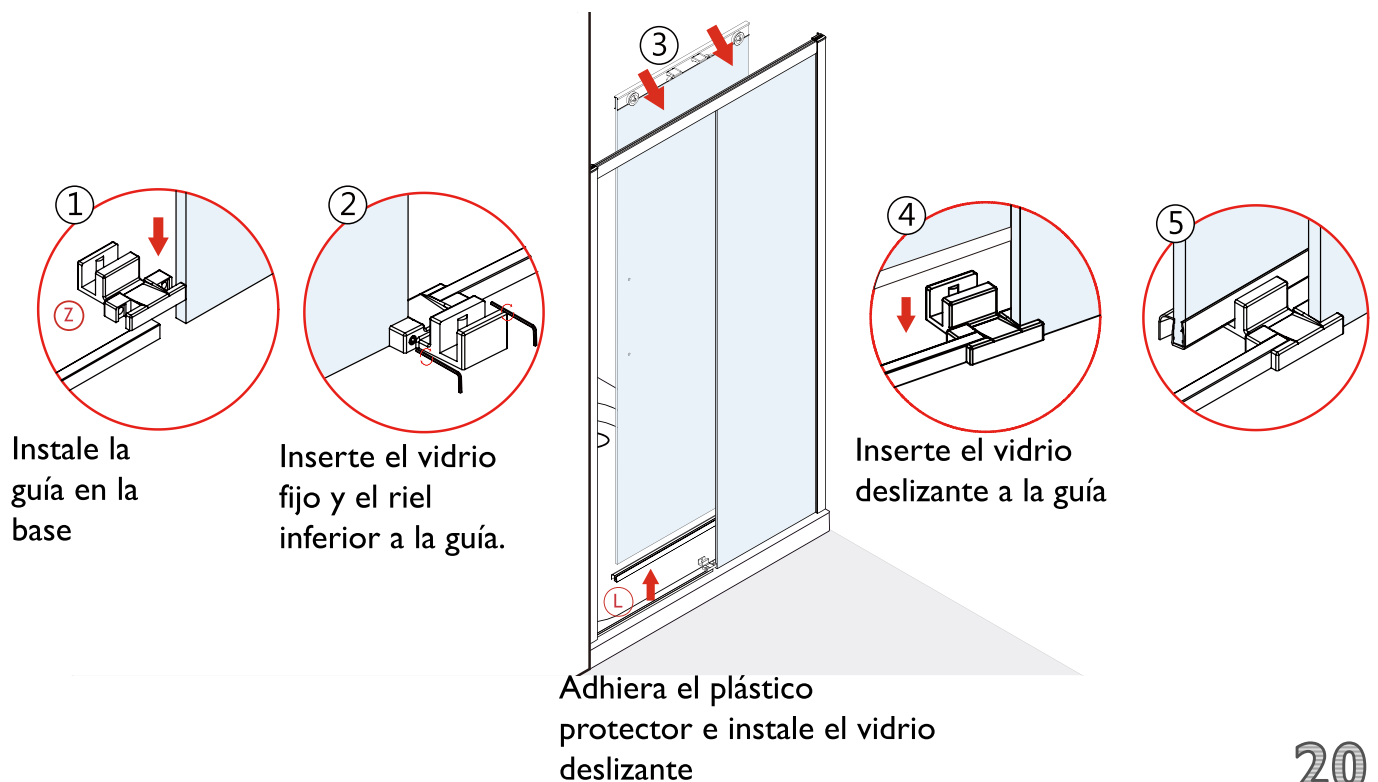

Paso 8: Instale los plásticos protectores y la manija

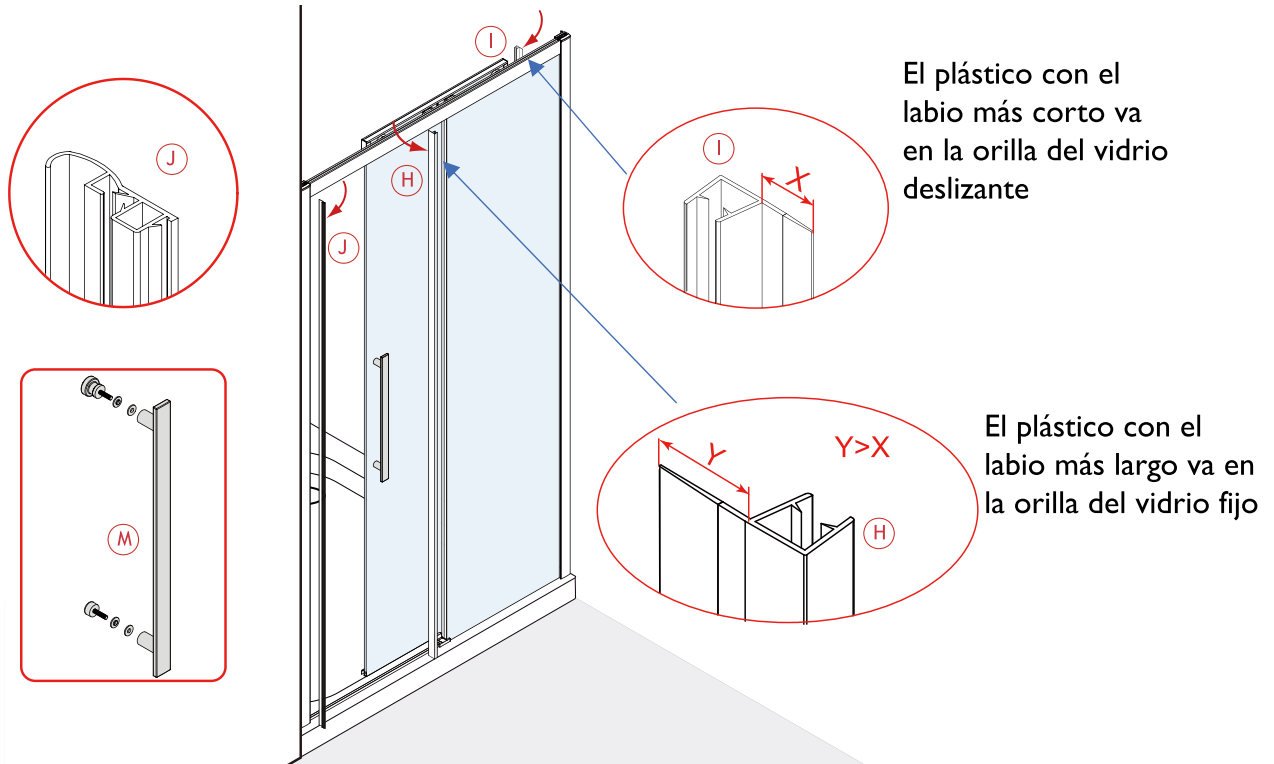

Paso 9: Ajuste las ruedas y el mecanismo de cierre suave

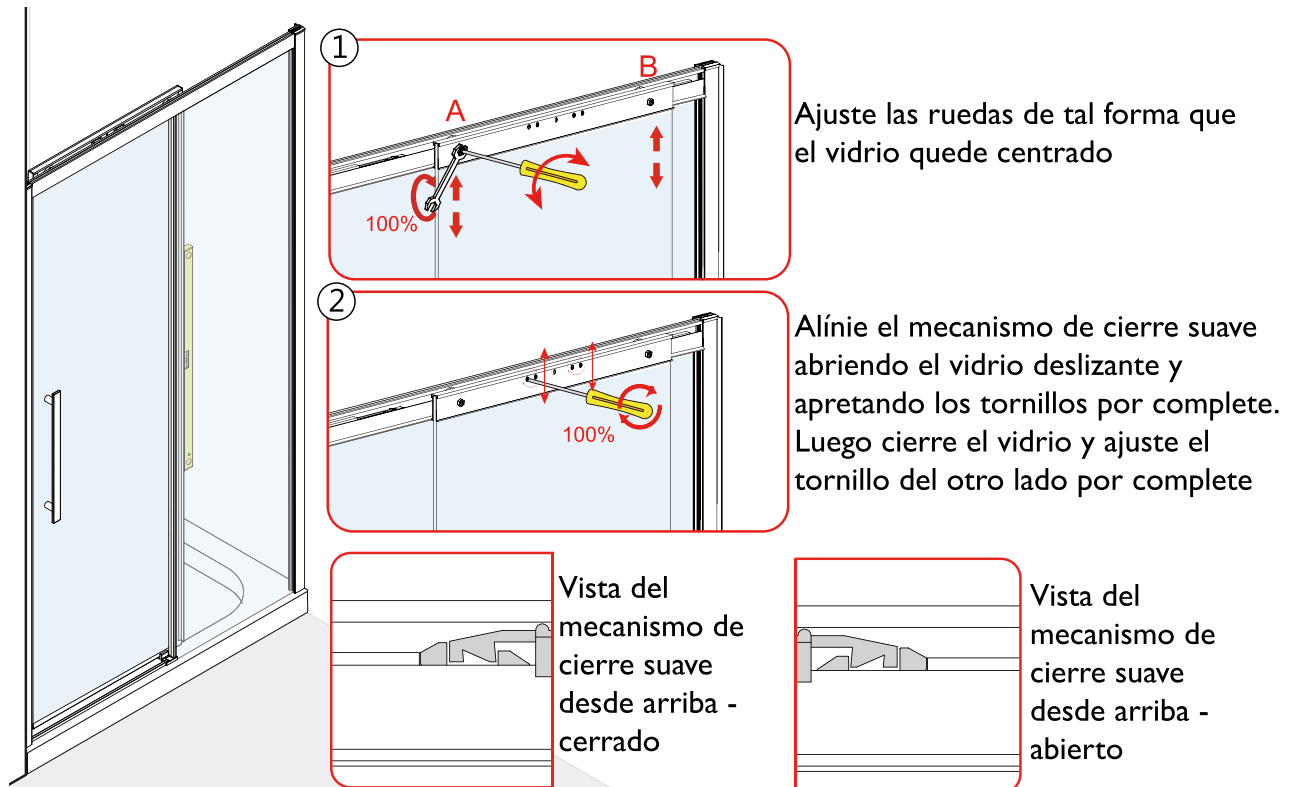

Paso 10: Inserte la cubierta del riel superior

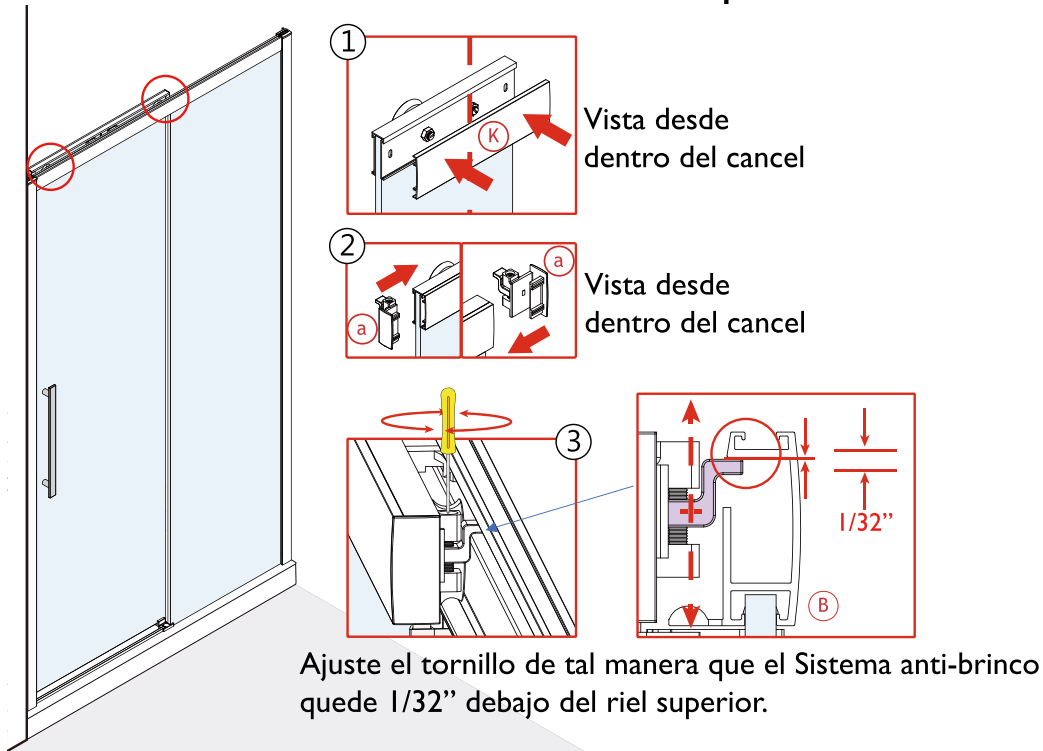

Paso 11: Aplique silicón en el perímetro del cancel, por dentro y por fuera

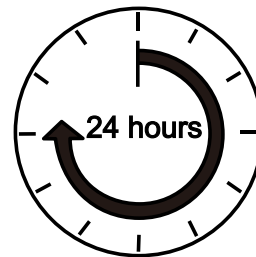
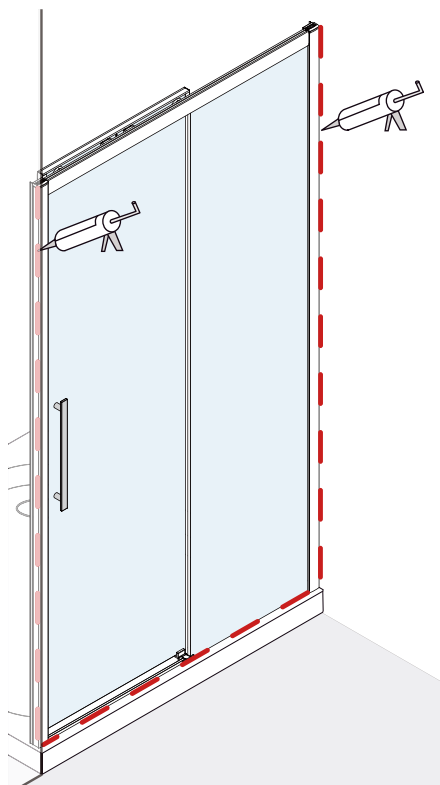

Permita que el silicón seque por 24 horas

NO UTILICE LA REGADERA