



• J-495™

• J-480™

• J-470™

• J-425™

• J-415™

J-400™ COLLECTION

EXPORT OWNER'S MANUAL

2530-442EE Rev A

Attention New Spa Owner!

Congratulations on the purchase of your new Jacuzzi® spa! The following is a list of automated functions performed by your spa. These functions are listed below in an attempt to suppress any operational concerns you may have during the first 24 hours of ownership! Also listed below are important maintenance recommendations you should observe on a regular basis to protect your new investment.

Maintain Healthy Spa Water

Always maintain your spa's water chemistry within the following parameters:

	With CLEARRAY®	Without CLEARRAY®
pH	7.4-7.6	7.4-7.6
Free chlorine	no less than 1.0 ppm	3.0-4.0 ppm
Free bromine	no less than 2.0 ppm	2.0-4.0 ppm
Total Alkalinity	100-150 ppm	100-150 ppm
Calcium Hardness	150-250 ppm	150-250 ppm

IMPORTANT: CLEARRAY® Water Purification System is factory installed. If the CLEARRAY® system is altered or is not operating efficiently then follow the "without CLEARRAY®" water chemistry parameters as defined by the Association of Pool and Spa Professionals. CLEARRAY® requires an annual bulb replacement to properly sanitize your water.

 **TO DECREASE RISK OF INFECTION OR DISEASE!** Always maintain your spa filter as outlined below to ensure healthy spa water. Refer to pages 59-62 (Sec. 13.0) for additional information.

Required Filter Maintenance

Your new spa is equipped with an advanced water filtration system that provides unsurpassed water quality! To ensure maximum water quality at all times, you should clean the skimming filter cartridge every 3 months, or as necessary. See pages 59-62 (Sec. 13.0) for detailed filter cartridge cleaning instructions.

Required Water Replacement

 **TO DECREASE RISK OF INFECTION OR DISEASE!** You should replace the spa's water every 3 months. The frequency depends on a number of variables including frequency of use, number of users and attention paid to water quality maintenance. You will know it is time for a change when you cannot control sudsing and/or you can no longer get the normal feel or sparkle to the water, even though the key water balance measurements are all within the proper parameters. See pages 67-69 (Sec. 14.0) for additional information.

**** Spa operations and functions subject to change without notice ****

Table of Contents

1.0	Important Spa Owner Information	1
2.0	FCC Notice	1
2.1	Industry Canada (IC) Information	1
3.0	Important Safety Instructions for all Spa Owners	2
3.1	Entrapment Risk	6
3.2	Hyperthermia	7
3.3	Important safety instructions	8
4.0	Choosing a Location	8
4.1	Outdoor Location	9
4.2	Indoor Location	10
4.3	Location for the Optional ProLink™ Remote Monitoring System	11
5.0	General Electrical Safety Instructions	12
6.0	Electrical Installation Instructions (240V Service)	13
7.0	Power Requirements	16
8.0	Spa Fill Up Procedure	18
9.0	Spa Features	23
9.1	J-495 Spa Features	23
9.2	J-495 Massage/Waterfall Selector Diagram	24
9.3	J-495 Air Controls Diagram	25
9.4	J-480 Spa Features	26
9.5	J-480 Massage/Waterfall Selector Diagram	27
9.6	J-480 Air Controls Diagram	28
9.7	J-470 Spa Features	29
9.8	J-470 Massage/Waterfall Selector Diagram	30
9.9	J-470 Air Controls Diagram	31
9.10	J-425 Spa Features	32
9.11	J-425 Massage/Waterfall Selector Diagram	33
9.12	J-425 Air Controls Diagram	34
9.13	J-415 Spa Features	35
9.14	J-415 Massage/Waterfall Selector Diagram	36
9.15	J-415 Air Controls Diagram	37
10.0	Registration and Start-up	38
10.1	Start-up Sequence	38
10.2	Register Your New Spa	38
10.3	ProTouch™ Control Panel	39

11.0	Operating Instructions.....	41
11.1	ProTouch™ Control Panel	41
11.2	Activating the Jets Pumps	41
11.3	Lights Menu	42
11.4	Music Menu	43
11.5	Connecting the BLUEWAVE® System with your Bluetooth® device	44
11.6	Audio Settings Menu.....	45
11.7	CLEARRAY on Demand.....	45
11.8	Adjusting Jet Flow.....	46
11.9	Adjusting PowerPro™ MX2 Jets.....	46
11.10	Adjusting RX Jets	46
11.11	WaterColour™ Waterfall Control	46
11.12	Air Controls	46
11.13	Selecting the Desired Massage Action	46
12.0	Programming and Operation Instructions.....	47
12.1	Programming the Heating Mode.....	48
12.2	Programming the Primary Filter.....	49
12.3	Programming the Secondary Filter.....	50
12.4	Cleanup Cycle	51
12.5	Blow-Out Cycle	51
12.6	Water Care Programming.....	51
12.7	Optional Wi-Fi Setup.....	54
12.8	Locking the Spa.....	55
12.9	Programming the Time and Date.....	56
12.10	Programming the Language	57
12.11	Units Display.....	57
12.12	System Information.....	58
13.0	Spa Maintenance.....	58
13.1	Cleaning the Filter Cartridges	59
13.2	Draining and Refilling.....	62
13.3	Cleaning the Spa Interior.....	64
13.4	Pillow Care.....	64
13.5	Maintaining the Synthetic Cabinet	64
13.6	Cleaning the Control Panel.....	64
13.7	Cover Care and Maintenance.....	64
13.8	Winterizing	65
13.9	Restarting Your Spa in Cold Weather	66

14.0	Water Quality Maintenance	67
14.1	pH Control.....	67
14.2	Sanitizing	67
14.3	Other Additives	68
14.4	CLEARRAY® (Ultraviolet) Water Purification System	68
14.5	CLEARRAY® Bulb Replacement and Quartz Tube Maintenance	69
15.0	Error/Display Messages	71
16.0	Troubleshooting Procedures	75
17.0	Circuit Board Wiring Diagrams.....	77
17.1	J415/J425/J470/J480 Export 50Hz Wiring Diagram	77
17.2	J495 Export 50Hz Wiring Diagram	78
17.3	Dip Switch Settings.....	79
17.4	Single Service 50Hz Connection	82
17.5	Dual Service 50Hz Connection.....	83
17.6	Three Service 50Hz Connection.....	84

1.0 Important Spa Owner Information

Your Jacuzzi® spa is constructed to the highest standards and is capable of providing many years of trouble-free use. However, because heat retentive materials are utilized to insulate the spa for efficient operation, an uncovered spa surface and wall fittings directly exposed to sunlight and high temperatures for an extended period are subject to permanent damage or discoloration. Damage caused by exposing the spa to this abuse is not covered under warranty. We recommend that you always keep the spa full of water when it is exposed to direct sunlight and that you keep the Jacuzzi insulating cover in place at all times when the spa is not in use. Read and carefully follow the requirements for your spa's support base found in the Section 4.0 titled, "Choosing a Location" (page 8).

Jacuzzi® spas constantly strives to offer the finest spas available, therefore, modifications and enhancements may be made which affect the specifications, illustrations and/or instructions contained herein.

2.0 FCC Notice

This device complies with part 15 of the FCC Rules. Operation is subject to the following two conditions: (1) This device may not cause harmful interference, and (2) this device must accept any interference received, including interference that may cause undesired operation.

This equipment has been tested and found to comply with the limits for a Class B Digital Device, pursuant to Part 15 of the FCC Rules. These limits are designed to provide reasonable protection against harmful interference in a residential installation. This equipment generates, uses and can radiate radio frequency energy and, if not installed and used in accordance with the instructions, may cause harmful interference to radio communications. However, there is no guarantee that interference will not occur in a particular installation. If this equipment does cause harmful interference to radio or television reception, which can be determined by turning the equipment off and on, the user is encouraged to try to correct the interference by one or more of the following measures:

1. Rearrange or relocate the receiving antenna;
2. Increase the separation between the equipment and receiver;
3. Connect the equipment into an outlet on a circuit different from the circuit connected;
4. Consult the dealer or an experienced radio/TV technician for help. (Changes or modifications not expressly approved by the party responsible for FCC compliance could void the user's authority to operate this equipment.)

2.1 Industry Canada (IC) Information

The installer of this radio equipment must ensure that the antenna is located or pointed such that it does not emit RF field in excess of Health Canada limits for the general population; consult Safety Code 6, obtainable from Health Canada's website: www.hc-sc.gc.ca.

J-400 Export

3.0 Important Safety Instructions for all Spa Owners

READ AND FOLLOW ALL INSTRUCTIONS CAREFULLY!

This spa was manufactured to meet the standards and specifications outlined in the “Virginia Graeme Baker Pool and Spa Safety Act” (VGB Safety Act). When installing and using this spa, basic safety precautions should always be followed, including:

1.  **DANGER: RISK OF SEVERE INJURY OR DROWNING!**
 - Extreme caution must be exercised to prevent unauthorized access by children.
 - To avoid accidents, ensure that children do not use this spa unless supervised at all times. Adult supervision is a critical safety factor in preventing children from drowning.
 - Use the straps and clip tie downs to secure the spa cover when not in use. This will help discourage unsupervised children from entering the spa. Keep the spa cover secure in high-wind conditions.
 - There is no representation that the cover, clip tie-downs, or actual locks will prevent access to the spa.

2.  **DANGER: RISK OF SEVERE INJURY OR DROWNING!**
 - Keep hair, loose articles of clothing or hanging jewelry away from suction fittings, rotating jets or other moving components to avoid entrapment that could lead to drowning or severe injury.
 - Never use the spa unless all suction guards, filter, filter lid, or skimmer assembly are installed to prevent body and/or hair entrapment.
 - Never operate or use the spa if the filter, filter lid, or skimmer assembly are broken or any part of the skimmer assembly is missing. Please contact your dealer or nearest service center for service.
 - The suction fittings and suction covers in this spa are sized to match the specific water flow created by the pump(s). If it is necessary to replace the suction fittings, suction covers or pump(s), be sure that the flow rates are compatible and are in compliance with the VGB Safety Act.
 - Never replace a suction fitting or suction cover with one rated less than the flow rate marked on the original suction fitting. Using improper suction fittings or suction covers can create a body or hair suction entrapment hazard that may lead to drowning or severe injury.

3.  **DANGER: RISK OF SEVERE INJURY FROM ELECTRIC SHOCK OR DEATH FROM ELECTROCUTION!**
 - Install the spa at least 5 feet (1.5m), from all metal surfaces. As an alternative, a spa may be installed within 5 feet of metal surfaces if each metal surface is permanently connected (bonded) by a minimum No. 8 AWG (8.4 mm²) solid copper conductor attached to the wire connector on the grounding lug, inside the equipment compartment on the equipment box.

J-400 Export

- A grounding wire connector is provided on this unit to connect a minimum No. 8 AWG (8.4 mm²) solid copper conductor between this unit and any metal equipment, metal enclosures of electrical equipment, metal water pipe, or conduit within 5 feet (1.5m) of the unit.
- Never permit any electrical appliance, such as a light, telephone, radio, television, etc. within 5 feet (1.5m) of a spa unless such appliances are built-in by the manufacturer.
- Never bring any electrical appliances into or near the spa.
- Never operate any electrical appliances from inside the spa or when you are wet.
- The electrical supply for this product must include a suitably rated switch or circuit breaker to open all ungrounded supply conductors to comply with Section 422-20 of the National Electrical Code/USA, ANSI/NFPA 70. The disconnecting means must be readily accessible and visible to the spa occupant but installed at least 5 feet (1.5m), from the spa.
- The electrical circuit supplied for the hot tub must include a suitable ground fault circuit interrupter (GFCI) as required by NEC Article 680-42.



4.  **WARNING: RISK OF SEVERE INJURY OR DEATH!**



- Extreme caution must be exercised to prevent diving or jumping into the spa or slipping and falling, which could result in unconsciousness, drowning, or serious injury. Remember that wet surfaces can be very slippery.
- Never stand, walk or sit on the top railing of the spa.

5.  **WARNING: RISK OF HYPERTHERMIA (OVER-HEATING) CAUSING SEVERE INJURY, BURNS, WELTS OR DEATH!**

- Water temperature in excess of 40°C (104°F) may be injurious to your health.
- Refer to Section 3.2 Hyperthermia for specific causes and symptoms of this condition.
- The water in the spa should never exceed 40°C (104°F). Water temperatures between 38°C (100°F) and 40°C (104°F) are considered safe for a healthy adult.
- Lower water temperatures are recommended for young children (children are especially sensitive to hot water) and when spa use may exceed 10 minutes.
- The Consumer Products Safety Commission/USA has stated that the water temperature in a spa should not exceed 40°C (104°F).
- Always test the spa water temperature before entering the spa. The user should measure the water temperature with an accurate thermometer since the tolerance of water temperature-regulating devices may vary as much as 2°C (+/- 5°F).

J-400 Export

6.  **WARNING: RISK OF SEVERE INJURY OR DEATH!**
- Since excessive water temperatures have a high potential for causing fetal damage during the early months of pregnancy, if pregnant or possibly pregnant, consult your physician before using a spa.
 - Pregnant or possibly pregnant women should limit spa water temperatures to 38°C (100°F).
 - Persons suffering from obesity or a medical history of heart disease, low or high blood pressure, circulatory system problems, diabetes, infectious diseases or immune deficiency syndromes should consult a physician before using a spa.
 - If you experience breathing difficulties in association with using or operating your spa, discontinue use and consult your physician.
 - Persons using medication should consult a physician before using a spa since some medication may induce drowsiness, while other medication may affect heart rate, blood pressure, and circulation.
 - Persons suffering from any condition requiring medical treatment, the elderly, or infants should consult with a physician before using a spa.
 - The use of alcohol, drugs, or medication before or during spa use may lead to unconsciousness with the possibility of drowning.
7.  **WARNING: RISK OF SEVERE INJURY OR DEATH!**
- Prolonged immersion in a spa may be injurious to your health.
 - Observe a reasonable time limit when using the spa. Exposures at higher temperatures can cause high body temperature (overheating). Symptoms may include dizziness, nausea, fainting, drowsiness, and reduced awareness. These effects could possibly result in drowning or serious injury.
 - Never use a spa immediately following strenuous exercise. Enter and exit the spa slowly. Wet surfaces can be slippery.
8.  **WARNING: TO DECREASE RISK OF INFECTION OR DISEASE!**
- To reduce the risk of contracting a waterborne illness (e.g. an infection, bacteria or virus) and/or respiratory ailments, maintain water chemistry within the parameters listed on the inside cover of this manual and consult with a licensed engineer regarding proper ventilation if installed indoors or in an enclosed area.
 - People with infectious diseases should not use a spa to avoid water contamination, which could result in spreading infections to others.
 - Always shower before and after using your spa. Maintain water chemistry in accordance with manufacturer's instructions. Failure to do so may result in contracting a waterborne illness (e.g. an infection, bacteria or virus).

9.  **WARNING:** In addition to maintenance of filters and water chemistry, proper ventilation is recommended to reduce the risk of contracting a waterborne illness (e.g. an infection, bacteria or virus) and/or respiratory ailments that could be present in the air or water. Consult a licensed architect or building contractor to determine your specific needs if installing your hot tub indoors.
10. **CAUTION: TO DECREASE RISK OF PRODUCT DAMAGE.**
- Maintain water chemistry in accordance with manufacturer's instructions.
 - Proper chemical maintenance of spa water is necessary to maintain safe water and prevent possible damage to spa components.
11.  **WARNING: RISK OF SEVERE INJURY OR DEATH!** The appliance is not intended for use by persons (including children) with reduced physical, sensory or mental capabilities, or lack of experience or knowledge, unless they have been given supervision or instruction concerning use of the appliance by a person responsible for their safety.
12. **NOTE:** This spa is not intended nor designed to be used in a commercial or public application. The spa buyer shall determine whether there are any code restrictions on the use or installation of this spa since local code requirements vary from one locality to another.

Hot Tub Safety Literature

To ensure you have a safe and enjoyable hot tub experience, learn all you can about hot tub safety and emergency procedures. Especially useful are the brochures listed below:

- [Children Aren't Waterproof](#)
- [Pool and Spa Emergency Procedures For Infants and Children](#)
- [Layers of Protection](#)
- [The Sensible Way to Enjoy Your Spa or Hot Tub](#)

The Association of Pool and Spa Professionals publishes these brochures. To acquire a brochure:

- Ask your hot tub dealer (they may have copies)
- Go to <http://apsp.org>
- Conduct your own search on the internet
- Write to the following address:

The Association of Pool and Spa Professionals
2111 Eisenhower Avenue
Alexandria VA 22314
703.838.0083

J-400 Export

3.1 Entrapment Risk

The Consumer Products Safety Commission/USA has reported that users of pools and spas have become entrapped (stuck) to drain and/or suction fittings causing death, drowning, or serious injury (see diagram below). This spa was manufactured to meet the standards and specifications outlined in the "Virginia Graeme Baker Pool and Spa Safety Act" (VGB Safety Act). Entrapment risk can be minimized if proper precautions are taken.



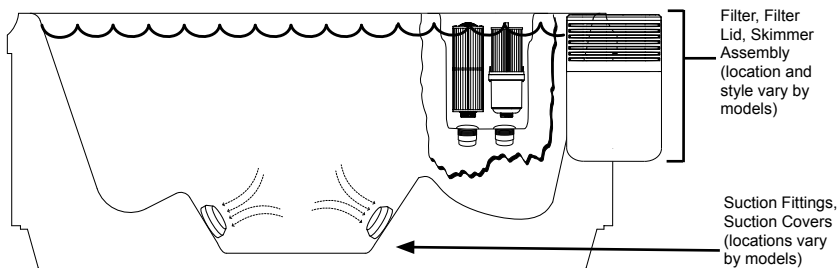

DANGER: RISK OF PERSONAL INJURY OR DEATH!

Never operate the spa if a suction fitting, suction cover, filter, filter lid or skimmer assembly are broken, damaged or missing.



Note: Suction covers must be replaced every 5 years.

-  **DANGER: RISK OF SEVERE INJURY OR DROWNING!**
Hair entrapment: May occur if hair is entangled, knotted or snagged in a drain suction or skimmer assembly. This has been reported in persons who when submerge themselves underwater, allowing hair to come close and/or within the reach of the suction fittings, suction covers or skimmer assembly.
 - Keep hair away from suction fittings, suction covers, filter, filter lid or skimmer assembly.
 - Children are at risk for hair entrapment if swimming under water.
 - Never allow children to play or get near the suction fittings, suction covers, filter, filter lid or skimmer assembly.
-  **DANGER: RISK OF SEVERE INJURY OR DROWNING!**
Limb entrapment: May occur when a limb becomes entrapped, inserted or sucked into a suction or outlet opening.
 - Always keep suction fittings, suction covers, filter, filter lid or skimmer assembly in place when operating to avoid limb entrapment.
 - Never allow children to play or get near the suction fittings, suction covers, filter, filter lid or skimmer assembly.

3.  **DANGER: RISK OF SEVERE INJURY OR DROWNING!**
Body entrapment: May occur when part of the torso becomes entrapped, inserted or sucked into a suction or outlet opening.
 - Never allow children to play or get near the suction fittings, suction covers, filter, filter lid or skimmer assembly.

4.  **DANGER: RISK OF SEVERE INJURY OR DROWNING!**
Evisceration (disembowelment) entrapment: May occur when the buttocks becomes entrapped, inserted or sucked into a suction or outlet opening.
 - Never sit on suction fittings, suction covers, filter, filter lid or skimmer assembly.
 - Never allow children to play or get near the suction fittings, suction covers, filter, filter lid or skimmer assembly.

5.  **DANGER: RISK OF SEVERE INJURY OR DROWNING!**
Mechanical entrapment: May occur when jewelry, swimsuit, or hair accessories become entangled, knotted or snagged in a drain suction or skimmer assembly.
 - Never allow your jewelry, swimsuit, or hair accessories to come close to the suction fittings, suction covers or skimmer assembly.
 - Never allow children to play or get near the suction fittings, suction covers, filter, filter lid or skimmer assembly.

3.2 Hyperthermia

Prolonged immersion in hot water may induce hyperthermia (overheating). The use of alcohol or drugs can greatly increase the risk of fatal hyperthermia in spas. A description of the causes, symptoms, and effects of hyperthermia are as follows:

Hyperthermia occurs when the internal temperature of the body reaches a level several degrees above the normal body temperature of 37°C (98.6°F). The symptoms of hyperthermia include drowsiness, lethargy (fatigue), and an increase in the internal temperature of the body (feeling of being too hot). The effects of hyperthermia include:

- Unawareness of impending hazard;
- Failure to perceive heat;
- Failure to recognize the need to exit spa;
- Physical inability to exit spa;
- Fetal damage in pregnant women; and
- Unconsciousness and danger of drowning.

A Warning Sign is provided in your warranty packet. Please install at a location near your spa, where it is visible to users of the spa. For additional or replacement Warning Signs please contact your local Jacuzzi dealer and reference item number #6530-082.

J-400 Export

3.3 Important safety instructions

When using this electrical equipment, basic safety precautions should always be followed, including the following:

1. **READ AND FOLLOW ALL INSTRUCTIONS.**
2. A green colored terminal or a terminal marked G, Gr, Ground, Grounding or the Ⓧ symbol* is located inside the supply terminal box or compartment. To reduce the risk of electric shock, this terminal must be connected to the grounding means provided in the electric supply service panel with a continuous copper wire equivalent in size to the circuit conductors that supply this equipment. *IEC Publication 417, Symbol 5019.
3. At least two lugs marked “Bonding Lugs” are provided on the external surface or on the inside of the supply terminal box/ compartment. To reduce the risk of electric shock, connect the local common bonding grid in the area of the spa to these terminals with an insulated or bare copper conductor not smaller than No. 6 AWG (10 mm²).
4. All field-installed metal components such as rails, ladders, drains or other similar hardware within 10 feet (3m) of the spa shall be bonded to the equipment grounding buss with copper conductors not smaller than No. 6 AWG (10 mm²).
5. **SAVE THESE INSTRUCTIONS.**

4.0 Choosing a Location

IMPORTANT: Because of the combined weight of the spa, water and users, it is extremely important that the base upon which the spa rests be smooth, flat, level and capable of uniformly supporting this weight, without shifting or settling, for the entire time the spa is in place. If the spa is placed on a surface, which does not meet these requirements, damage to the skirt and/or the spa shell may result. Damage caused by improper support is not covered under warranty. It is the responsibility of the spa owner to assure the integrity of the support at all times. We recommend a poured, reinforced concrete slab with a minimum thickness of 4 inches (10 cm). Wood decking is also acceptable provided it is constructed so that it meets the requirements outlined above.



WARNING: For spas that are to rest on balconies, roofs or other platforms not specifically tied into main structural support, consult a professional Structural Engineer with experience in this type of application.

The spa must be installed in such a manner as to provide drainage away from it. Placing the spa in a depression without provisions for proper drainage could allow rain, overflow and other casual water to flood the equipment and create a wet condition in which it would sit in. For spas which will be recessed into a floor or deck, install so as to permit access to the equipment, either from above or below, for servicing. Make certain that there are no obstructions, which would prevent removal of all side cabinet side panels and access to the jet components, especially on the side with the equipment bay.



CAUTION: If the spa is indoors or located in an enclosed area, proper ventilation should be discussed with an Engineer or authority competent enough to understand the necessary provisions needed to vent moist or heated air and air associated with chemical odors outdoors. **When the spa is in use considerable amounts of moisture will escape potentially causing mold and mildew. This can cause health risk.** Over time, this can damage certain surfaces, surroundings, and equipment.

4.1 Outdoor Location

In selecting the ideal outdoor location for your spa, we suggest that you take into consideration:

- The proximity to changing area and shelter (especially in colder weather).
- The pathway to and from your spa (this should be free of debris so that dirt and leaves are not easily tracked into the spa).
- The closeness to trees and shrubbery (remember that leaves and birds could create extra work in keeping the spa clean).
- A sheltered environment (less wind and weather exposure can result in lowered operation and maintenance costs).
- The overall enhancement of your environment. It is preferable not to place the spa under an unguttered roof overhang since run-off water will shorten the life expectancy of the spa cover.
- For spas that are to rest on balconies, roofs or other platforms not specifically tied into main structural support, consult a professional Structural Engineer with experience in this type of application.
- In the unlikely event that you should ever need to access or gain entry to any portion of the spa for servicing, it is highly recommended that you plan your outdoor installation to provide full access to the entire spa. Please take this into consideration when placing the spa in a deck or enclosed by a surrounding.
- Consider locating your spa away from any reflective surface or glass to prevent any damage to the synthetic skirt.
- Do not shim the spa. To ensure proper support the spa must sit flat on the intended foundation.

J-400 Export

4.2 Indoor Location

For indoor installations many factors need to be considered before installing a spa indoors.



WARNING: In addition to maintenance of filters and water chemistry, proper ventilation is recommended to reduce the risk of contracting a waterborne illness (e.g. an infection, bacteria or virus) and/or respiratory ailments that could be present in the air or water. Consult a licensed architect or building contractor to determine your specific needs if installing your hot tub indoors.

- **Proper Foundation: Consult a Structural Engineer when considering a foundation that will adequately support the spa the entire time it is in place.** Proper support is critical especially if the spa is to rest on a second story or higher. For spas that are to rest on balconies, roofs or other platforms not specifically tied into the main structural support, you should consult a professional Structural Engineer with experience in this type of application.
- **Proper Drainage: It is extremely important to have in place measures to sufficiently handle excessive water spillage.** Be sure the flooring in which the spa rests on has adequate drainage and can handle the entire contents of the spa. Be sure to make provisions for ceilings and other structures that may be below the spas installation. Areas around your spa can become wet or moist so all flooring and subsequent furniture, walls and adjacent structures should be able to withstand or resist water and moisture.
- **Proper Ventilation: Proper ventilation should be discussed with an Engineer or authority competent enough to understand the necessary provisions needed to vent moist or heated air and air associated with chemical odors outdoors.** When the spa is in use considerable amounts of moisture will escape, potentially causing mold and mildew over time, which can damage certain surfaces and/or surroundings.
- **Sufficient Access:** In the unlikely event that you should ever need to access or gain entry to any portion of the spa for servicing, it is highly recommended that you plan your indoor installation to provide full access to the entire spa.
- **Warranty:** Damage caused by not following these guidelines or any improper installation not in accordance to local codes or authorities is not covered under the spas warranty. Please consult your local state or city building ordinances.
- **Do not shim the spa.** To ensure proper support the spa must sit flat on the intended foundation.

4.3 Location for the Optional ProLink™ Remote Monitoring System

IMPORTANT! Choose an installation site with the front control panel side pointing towards your home's Wi-Fi router.

CAUTION: You must make sure that the spa control panel side has a clear unobstructed line-of-site of the home Wi-Fi router. This action ensures maximum signal strength between the spa and your home's Wi-Fi router.

Verify your home router's Wi-Fi strength at the proposed spa location. Front control panel side of spa must point towards your home's Wi-Fi router in your home as illustrated, Figure 4.3a. Stand near the proposed front control panel side of the spa with your cell phone, then login to the internet using your home Wi-Fi router signal (not 3G or 4G) and verify results as follows:

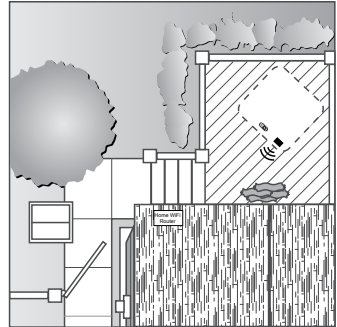

Figure 4.3a

If the home Wi-Fi router signal is strong (3-4 bars) and Internet access is stable, the proposed installation site is a good choice.

If the home router's Wi-Fi signal is weak and Internet access is slow or produces an error, the proposed installation site is not a good choice.

- It may be necessary to choose another spa installation site.
- Relocate your home Wi-Fi router closer to the spa.
- Install a "repeater" device in the room closest to the spa to boost the home's router Wi-Fi signal at the proposed spa installation site.

System and Wi-Fi Router Requirements

- a. The hardware for the Jacuzzi ProLink™ communicates over a 2.4 GHz home network supporting 802.11b/g wireless technology. The hardware does not support 5 GHz networks.
- If you have 2 Wi-Fi networks, one at 2.4 GHz and the other at 5 GHz, then make sure that your smart phone is connected to the 2.4 GHz network throughout the setup process. It is recommended that you turn off your 5 GHz network during the setup process.

NOTE: The system does not support 802.11/ac/n. If your Wi-Fi router is either 802.11ac or n, it may work with the module if it supports 802.11b/g.

- b. Standard wireless setup supports only home network routers configured to use open (no security) or WEP/WPA/WPA2.
- c. Wi-Fi signal strength of -60 dBm or better is highly suggested to ensure non-interrupted cloud service.

J-400 Export

- d. The wireless access is not supported on the following systems:
- Guest networks/Hotspots that use a portal page to login.
 - Enterprise access points configured to require certificates or some other form of enterprise authentication (aka “802.1X”, “RADIUS”, or “WPA/WPA2 Enterprise”).
- e. List of compatible routers and access points is published on Jacuzzi’s website www.jacuzzi.com/hot-tubs/owners-corner/remote-control/
- f. The Wi-Fi module does not prefer any channels (1-11) on the 2.4 GHz band. A Wi-Fi spectrum analyzer can be used to check how many Wi-Fi networks are operating on different channels on the 2.4 GHz band. If there are too many networks on channel 6 (for instance), then it is recommended that the customer change the operating channel of their Wi-Fi network. Most routers auto-change the channel but there are some routers that may have to be changed manually.
- g. If there are too many devices operating on a customer’s home Wi-Fi network that may affect the connectivity of the Wi-Fi module (check the maximum number of devices that can be connected to the Access Point that the customer is using).

5.0 General Electrical Safety Instructions

Your new Jacuzzi® spa is equipped with the ProTouch™ system. It contains the most advanced safety and self-protective equipment in the industry. Nonetheless, this spa must be installed properly to ensure dependable usage.

Please contact your local Jacuzzi dealer or local building department should you have any questions regarding your installation.

Proper grounding is extremely important. Jacuzzi spas are equipped with a current collector system. A pressure wire connector is provided on the surface of the control box, located inside the equipment door (page 14) to permit connection of a bonding wire between this point and any ground metal equipment, metal water pipe or conduit within 5 feet (1.5m) of the spa, or copper clad grounding rod buried within 5 feet (1.5m) of the spa. Bonding wire must be at least No. 8 AWG (8.4 mm²) solid copper wire. This is a most important safety assurance feature. Before installing your spa, check with your local building department to ensure installation conforms to local building codes.



6.0 Electrical Installation Instructions (240V Service)

IMPORTANT NOTICE: The electrical wiring of this spa must meet the requirements of the National Electrical Code/USA (NEC) and/or any applicable state or local codes. The electrical circuit must be installed by a qualified electrician and approved by a local building/electrical inspection authority.



1.  **DANGER: TO DECREASE THE RISK OF SHOCK, PRODUCT DAMAGE OR ELECTRICAL FIRE.**
This spa must be permanently connected (hard-wired) to the power supply. **No plug-in connections or extension cords are to be used in conjunction with the operation of this spa.** Supplying power to the spa, which is not in accordance with these instructions, will void both the independent testing agency listing and the manufacturer's warranty.
2. The power supplied to this spa must be a dedicated circuit with no other appliances or lights sharing the power provided by the circuit.
3. To determine the current, voltage and wire size required, refer to Section 7.0 "Power Requirements" (page 16) for your specific spa model.
 - Wire size must be appropriate per NEC and/or local codes.
 - The spa controller's terminal block will accept a maximum wire size of 6 AWG.
4. The electrical supply for this product must include a suitably rated switch or circuit breaker to open all ungrounded supply conductors to comply with Section 422-20 of the National Electrical Code/USA, ANSI/NFPA 70. The disconnecting means must be readily accessible to the spa's occupant but installed at least 5 feet (1.5m) from spa water.
5. The electrical circuit supplied for the spa must include a suitable ground fault circuit interrupter (GFCI) as required by NEC Article 680-42/USA.
6. For Australia/ New Zealand, the spa should be supplied through a residual current device (RCD) with a rated tripping current not exceeding 30mA (IEC 60335-2-60).
7. To gain access to the spa's power terminal block, press the release button securing the cabinet panel under the control panel. See page 63 for instructions on how to remove the cabinet panel(s). Then remove the door screws on the control box (Figure A). Place the panel in a safe location to prevent damage.
8. Select the power supply entrance you want to use, Figure A. Make sure to install a 3/4" electrical fitting and conduit through the large opening provided in the bottom of the control box so you can feed the cable through to the terminal block.
9. Connect wires to the terminal block (Figures B-6.0C). **ALL WIRES MUST BE SECURELY CONNECTED** or equipment damage could result!
10. Install control access box door and reinstall the cabinet panel(s).

Figure A
Equipment Area



Note: Equipment location and quantity (such as pumps, CLEARRAY system, stereo, drain, heater etc.) varies by model.

- | | |
|--|---|
| 1. ProTouch™ Control Panel | 9. Pump Drain Plug(s) |
| 2. ProTouch™ Control Box | 10. Power Supply Entrance(s) |
| 3. Heater | 11. Spa Drain Valve |
| 4. Filter/Circulation Pump | 12. BLUEWAVE® 2.0 Wireless Stereo (Optional) |
| 5. Jets Pump | 13. ProLink™ Remote Monitoring System Module (Optional) |
| 6. Jets Pump | 14. LED Lights DCU unit |
| 7. CLEARRAY® Water Purification System | |
| 8. QuickDrain™ | |

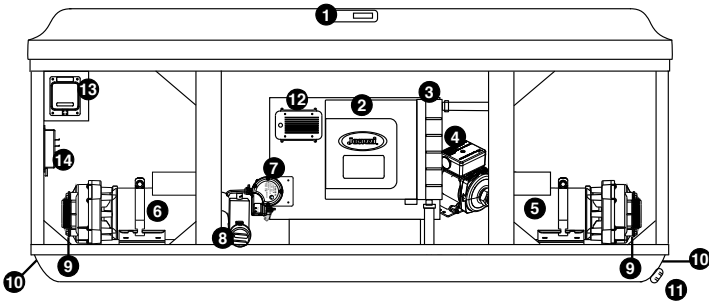
Figure B Control Box

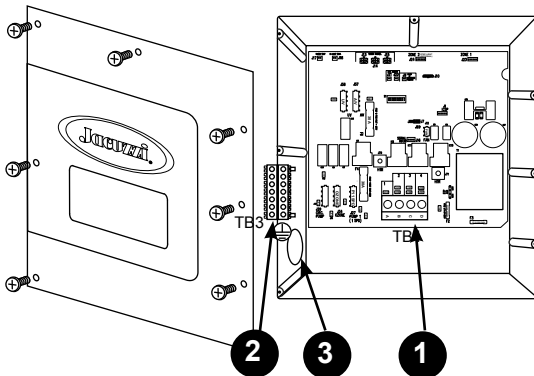

1. Main Terminal
2. Bonding Lug/Grounding Terminal
3. Power wires entrance (electrical fitting and conduit must be installed)

Figure C (Terminal Block 230V/50z Connection)

***IMPORTANT NOTE:** Wire connections on controller board must be changed depending on the number of breakers being used, pages 82 and 84.

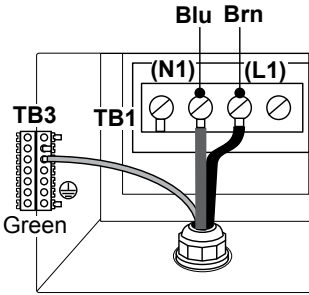

Service 1

- Brn (L1)
- Blu (N1)

Factory Default

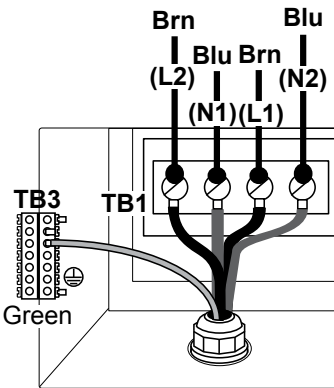

Service 1

- Blu (N1)
- Brn (L1)

Service 2

- Brn (L2)
- Blu (N2)

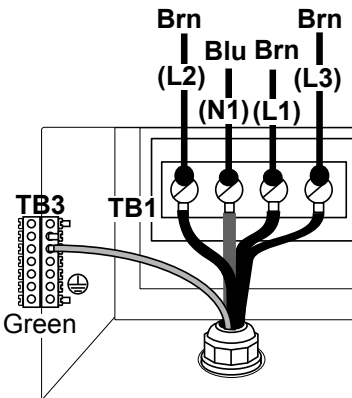

Service 1

- Blu (N1)
- Brn (L1)

Service 2

- Brn (L2)

Service 3

- Brn (L3)

J-400 Export

7.0 Power Requirements

Jacuzzi® spas are designed to provide optimum performance and flexibility of use when connected to their maximum electrical service. They are configured at the factory. The most common electrical connections are listed below:

Export 50 Hz (1 Breaker Connection)

	Single Breaker Service 1 (including Heater)*	Single Breaker Service 1 (including Heater)**
Voltage:	230 VAC	230 VAC
<u>Max. Current Draw:</u>		
1-Pump System	15A	22A
2-Pump System	17A	29A
3-Pump System	29A	36A
<u>Wattage:</u>		
1-Pump System	3,5kW	5,1kW
2-Pump System	3,9kW	6,7kW
3-Pump System	6,7kW	8,3kW
Frequency:	50 Hz	50 Hz
Number of Wires:	3	3

Single breaker configuration is the factory default.

- * In this configuration, the heater **will not operate** while any jets pump is running. The service 1 breaker will include connection for all components.
- ** In this configuration, the heater **will operate** while one or two jets pumps are running. The service 1 breaker will include connection for all components.

Export 50 Hz (Two and Three Breaker Connections)

	Dual Service Breakers Service 1/Service 2 Breaker***	Three Phase Service Service 1 /Service 2/ Service 3 Breaker****
Voltage:	230 VAC	230 VAC
<u>Max. Current Draw:</u>		
1-Pump System	12A/10A	N/A
2-Pump System	12A/17A	12A/10A/7A
3-Pump System	12A/24A	12A/10A/14A
<u>Wattage:</u>		
1-Pump System	2,8kW/2,3kW	N/A
2-Pump System	2,8kW/3,9kW	2,8kW/2,3kW/1,6kW
3-Pump System	2,8kW/5,5kW	2,8kW/2,3kW/3,2kW
Frequency:	50 Hz	50 Hz
Number of Wires:	5	5

- *** In this configuration, the heater **will operate** while one or two jets pumps are running.
For 1- or 2-pump system, the service 1 breaker will include connections for the heater and transformer. The service 2 breaker is for all other components.
For 3-pump system, the service 1 breaker will include connections the for heater and transformer. The service 2 breaker is for all other components.
- **** In this configuration, the heater **will operate** while all jets pumps are running. The service 1 breaker will include connections for the heater and transformer. Service 2 breaker is for pump 1 and other components. Service 3 breaker is for pump 2 and pump 3.

J-400 Export

8.0 Spa Fill Up Procedure

For best results, read each step in its entirety before proceeding with this procedure. Make sure that all drains and drain plugs are closed, page 14.

1. Prepare The Spa For Filling

- Clear all debris from the spa. (Although the spa shell has been polished at the factory, you may want to treat it with a specially formulated spa cleaner.) Consult your authorized Jacuzzi dealer for additional information prior to filling spa.
- Remove both ProClarity™ and ProClear™ Plus skimmer, polishing filter lids and filters as illustrated in Section 13.1 (page 59).

2. Fill Spa

- Place the end of your garden hose into empty skimming filter fitting as you stand next to the spa. Fill spa half way, then place the garden hose into the opposite filter fitting while adding the remaining fill water.

CAUTION: TO DECREASE BUILD UP ON COMPONENTS AND MINIMIZE ACRYLIC DAMAGE.

Never fill with water from a water softener. If your water is extremely “hard,” it is preferable to fill half-way with hard water and the rest of the way with softened water. Water that is too soft can be corrosive to metal components.

-  **WARNING: TO DECREASE RISK OF INFECTION OR DISEASE.**

Fill hot tub with clean tap water from garden hose, to reduce risk of contracting a waterborne illness (e.g. an infection, bacteria or virus) and/or respiratory ailments. Fill until water covers all jets but does not touch the bottom of the lowest headrest (DO NOT OVERFILL!).

IMPORTANT: Always fill your spa through both filter fittings after draining. Failure to do so may cause air to be trapped in the pumps, preventing the pumps from circulating water. Remove the hose and replace both filter cartridges as illustrated in Section 13.1 (page 59).

3. Turn On Power

Turn on power to spa at the home’s circuit breaker. The heater and filter/circulation pump will automatically activate. Normally, at the initial fill, the water tends to be cold. Refer to page 73 for additional information.

4. Activate Jets Pumps

Turn on jet pumps when adding chemicals in step 5 (see Section 11.2, page 41 to activate jets).

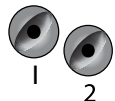

5. Add Start-Up Chemicals

Add the spa water chemicals as recommended by your authorized Jacuzzi spa dealer. See Section titled “Water Quality Maintenance” (page 67) for general guidance.



WARNING: RISK OF POISONING OR DEATH.

Never leave chemicals opened and accessible to anyone. Use chemicals according to the vendor’s instructions. Always store chemicals in a safe and/or locked location. Keep away from and out of reach of children.



6. Establish A Stable Sanitizer Reading

Establish a stable sanitizer reading of no less than 1.0 ppm free chlorine or 2.0 ppm bromine. To ensure healthy water conditions, always maintain a constant sanitizer reading within the levels recommended on the inside cover of this manual. If sanitizer levels cannot be stabilized, perform the decontamination procedure steps 9-15 on the following page.

Note: The “Decontamination Procedure” should also be used after the spa has been “Winterized” (Sec. 13.8, page 65) or has been sitting without power for an extended period.

7. Set Spa To Heat

To warm spa water to a comfortable temperature, follow these steps:

- The display on the control panel displays the actual temperature of the spa water. Tap  or  to increase or decrease the water temperature in 0,5°C (1°F) increments.
- The heater will turn off 0,5°C (1°F) above set temperature and turn on 1°C (2°F) below set temperature.

Note: The temperature range for the spa is 18.33 to 40°C (65 to 104°F). To activate the **Extended Temperature feature** that allows the spa to reach 41°C (106°F), see page 74.

Important Heater Details:

- The maximum temperature for which the spa can be set is 40°C (104°F) and the minimum is 27°C (80°F).
- For North American spas: With a 50 amp service, turn off one of the jet pumps to operate heater. With a 40 amp service, turn off jet pump(s) to operate heater. With a 60 amp service, the heater will operate with two jet pumps on.
- Setting the thermostat at maximum will not accelerate the heating process. This will only result in a higher ultimate temperature.
- The heater operates until the water reaches 0,5°C (1°F) above the programmed “set temperature,” then turns off. The heater will reactivate after the water cools to approximately 1°C (2°F) below the “set temperature.”

J-400 Export

8. Place Cover On Spa

- Keeping the insulating cover in place anytime the spa is not in use will reduce the time required for heating, thereby minimizing operating costs.
- The time required for initial heat-up will vary depending on the starting water temperature.



DANGER: RISK OF PERSONAL INJURY.

Check water temperature carefully before entering hot tub! Excessive water temperature can cause burns, welts and body temperature to rise, hyperthermia (over-heating).

Decontamination Procedure

Steps 9-15 below are only required when sanitizer levels are unstable after performing Spa Fill Up Procedures steps 1-6. Disregard steps 9-15 below if sanitizer levels remain stable after performing steps 1-6 above (refer to the inside cover of the manual).

9. Add 2.5 ounces of sodium dichlor for every 100 gallons of water. Refer to the table below for approximate water fill volume by model.



CAUTION: RISK OF PERSONAL INJURY OR SPA DAMAGE!

Never add chlorine tablets (trichlor) or acid to your hot tub for any reason! These chemicals may damage components within your hot tub, burn or irritate your skin, create a rash, and void the manufacturer warranty for your spa.

Water Fill Volume by Model

Model	Average Fill Volume*	Sodium Dichlor
J-415.....	230 Gal (871 L).....	5.75 oz
J-425.....	340 Gal (1,287 L).....	9.0 oz
J-470.....	450 Gal (1,703 L).....	11.0 oz
J-480.....	480 Gal (1,817 L).....	12.0 oz
J-495.....	560 Gal (2,120 L).....	14.0 oz

*Use average fill volume for chemical maintenance

10. Leave spa cover open during this step to allow excessive chemical vapors to exit spa, protecting pillows and plastic knobs from chemical attack. If spa is indoors, open doors and windows for proper ventilation.

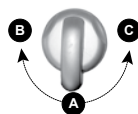

Turn on all spa jet pumps for one hour, open all air controls, and place all massage selector knob(s) in their center "combo" position.

Note: You will need to activate the jet pumps every 20 minutes since these functions have an automatic 20 minute time-out that turns them off.



WARNING: RISK OF PERSONAL INJURY!

- To decrease the risk of injury, drowning or entrapment, never leave your hot tub unattended for any reason while the cover is open and accessible, especially to small children and animals!
- Precautions should be taken to minimize your exposure to chemical vapors (that could cause lung, brain, or skin damage).

11. Turn off power to the spa at the circuit breaker, then drain tub as outlined in Section 13.2 (page 62).
12. Refill spa with clean tap water from garden hose until water covers all jets but does not touch the bottom of the lowest headrest with all headrests in their lowest position (DO NOT OVERFILL!)

CAUTION: TO DECREASE BUILD UP ON COMPONENTS AND MINIMIZE ACRYLIC DAMAGE.

Never fill with water from a water softener. If your water is extremely "hard," it is preferable to fill halfway with hard water and the rest of the way with softened water. Water that is too soft can be corrosive to metal components.

13. Consult your authorized Jacuzzi dealer for chemical recommendations, then add chemicals to hot tub water to achieve a constant sanitizer reading within the levels recommended on the inside cover of this manual.
14. Turn on jet pumps when adding chemicals to ensure proper mixing and leave your hot tub cover open until the sanitizer level becomes stable to protect pillows and plastic knobs from chemical attack. Refer to the inside cover of the manual.



WARNING: RISK OF PERSONAL INJURY.

- To decrease the risk of injury, entrapment or drowning, never leave your hot tub unattended for any reason while the cover is open and accessible to small children and animals!
- To decrease the possibility of contracting a waterborne illness (e.g. an infection, bacteria or virus) and/or respiratory ailments, maintain water chemistry within step 6 parameters. If you or other bathers experience such a condition, discontinue use and seek medical attention.

J-400 Export

15. Establish a sanitizer reading no less than 1.0 ppm free chlorine or 2.0 ppm bromine, then allow the hot tub to set undisturbed for 8 hours. Retest water after 8 hours to determine if sanitizer levels are stable. If sanitizer levels are stable, your spa is ready for use. To ensure healthy water conditions, always maintain a constant sanitizer reading within the levels recommended on the inside cover of this manual. If sanitizer levels are not stable at this time, it will be necessary to repeat this procedure in its entirety until stable sanitizer readings are achieved.

IMPORTANT: If the CLEARRAY® water purification system is removed from the hot tub or is not operating effectively follow the “without CLEARRAY®” water chemistry parameters as defined by the Association of Pool and Spa Professionals.

16. After adequate sanitizer levels are achieved, close all spa air controls to maximize heat retention when spa is not in use.

9.0 Spa Features

9.1 J-495 Spa Features

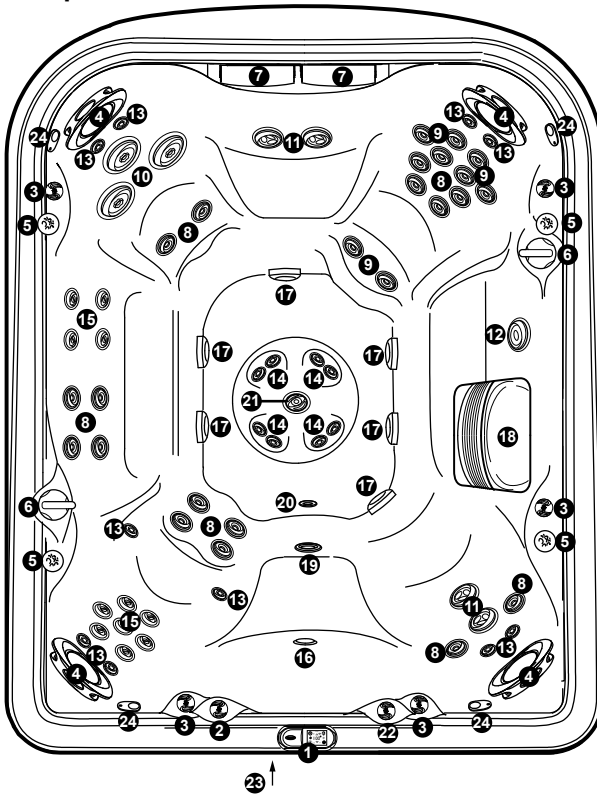

- | | |
|---|--|
| 1. ProTouch™ Control Panel | 13. NX2 Jets (10 ea.) |
| 2. Lighted IX Jet Flow Control Valve | 14. FX Small Jets (8 ea.) |
| 3. Air Control Valves (5 ea.) Introduce Air to Specified Jet Groups | 15. RX Jets (11 ea.) |
| 4. Adjustable Pillows (4 ea.) | 16. Underwater Light |
| 5. Lighted Cup Holders (4 ea.) | 17. Footwell Filter Suction Covers (6 ea.) |
| 6. Massage Selectors (2 ea.) Controls Specified Jet Groups | 18. Filter/Skimmer Grill |
| 7. Waterfalls (2 ea.) | 19. Waterfall Filtration Return |
| 8. FX Jets (18 ea.) | 20. Gravity Drain/Heater Input/CLEARARRAY Return Fitting |
| 9. FX Rotational Jets (6 ea.) | 21. Lighted IX Jet |
| 10. MX2 Jets (3 ea.) | 22. Waterfall Control Valve |
| 11. FX Large Rotational Jets (4 ea.) | 23. Optional BLUEWAVE® Audio System |
| 12. FX Large Jet (1 ea.) | 24. Optional Audio System Speakers (4 ea.) |

Spa features subject to change without notice

J-400 Export

9.2 J-495 Massage/Waterfall Selector Diagram

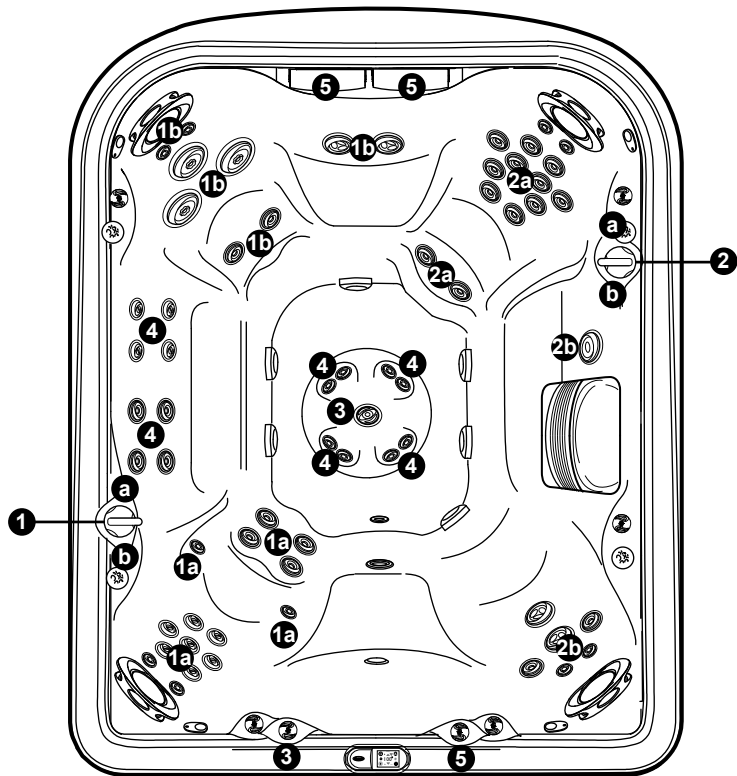

Massage Selectors (1-2)

- *Massage selector 1 diverts jets pump N° 2 output between jets groups 1a-1b.*
- *Massage selector 2 diverts jets pump N° 1 output between jets groups 2a-2b.*

IX Jet Flow Control Valve (3)

- *Valve (3) controls output to footwell IX Jet when jets pump N° 3 is running.*

Jets Without Massage Selector Controls (4)

- *Jets (4) are always on when jets pump N° 3 is running.*

Waterfall Selector (5)

- *Waterfall selector (5) controls circulation pump output to waterfall.*

9.3 J-495 Air Controls Diagram

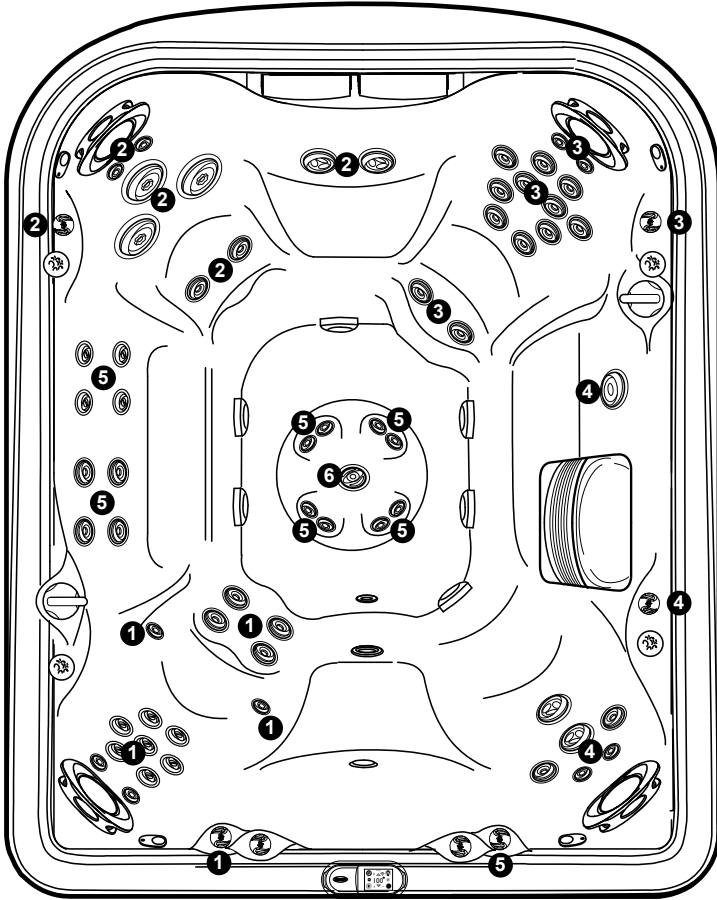

Air Controls Operation

- Rotate air controls 1-5 to add air to designated jet groups.
- Center footwell IX Jet (6) draws air at all times when jets pump N° 3 is running. This jet has no air control.

J-400 Export

9.4 J-480 Spa Features

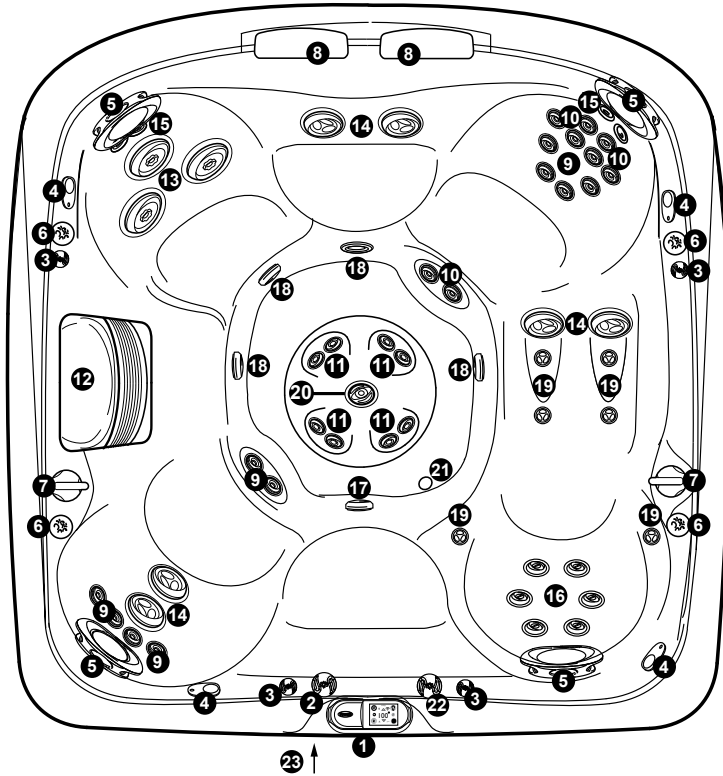

- | | |
|---|--|
| 1. ProTouch™ Control Panel | 13. MX2 Jets (3 ea.) |
| 2. Waterfall Control Valve | 14. FX Large Rotational Jets (6 ea.) |
| 3. Air Control Valves (4 ea.) Introduce Air to Specified Jet Groups | 15. NX2 Jets (4 ea.) |
| 4. Optional Audio System Speakers (4 ea.) | 16. RX Jets (6 ea.) |
| 5. Adjustable Pillows (4 ea.) | 17. Footwell Filter Suction Covers (4 ea.) |
| 6. Lighted Cup Holders (4 ea.) | 18. Waterfall Filtration Return |
| 7. Massage Selectors (2 ea.) Controls Specified Jet Groups | 19. PX Jets (6 ea.) |
| 8. Waterfalls (2 ea.) | 20. Lighted IX Jet |
| 9. FX Jets (12 ea.) | 21. Gravity Drain/Heater Input/CLEARRAY Return Fitting |
| 10. FX Rotational Jets (6 ea.) | 22. Lighted IX Jet Flow Control Valve |
| 11. FX Small Jets (8 ea.) | 23. Optional BLUEWAVE® Audio System |
| 12. Filter/Skimmer Grill | |

Spa features subject to change without notice

9.5 J-480 Massage/Waterfall Selector Diagram

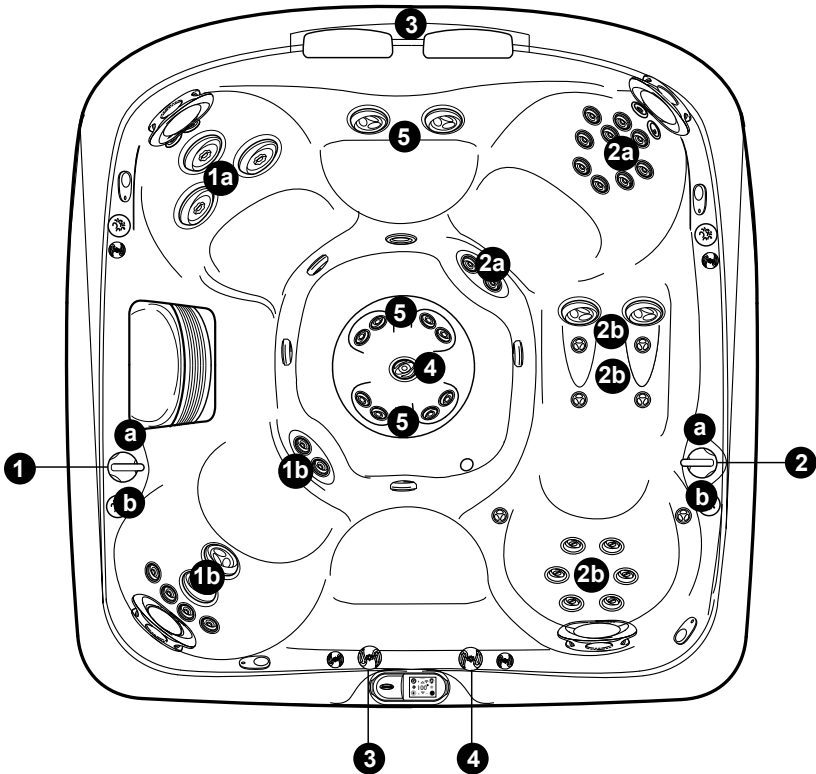

Massage Selectors (1-2)

- Massage selector 1 diverts jets pump N° 1 output between jet groups 1a-1b.
- Massage selector 2 diverts output jets pump N° 2 between jet groups 2a-2b.

Waterfall Selector (3)

- Waterfall selector 3 controls circulation pump output to waterfalls.

IX Jet Flow Control Valve (4)

- Valve (4) controls output to footwell IX Jet when jets pump N° 2 is running.

Jets Without Massage Selector Controls (5)

- Jets (5) are always on when jets pump N° 1 is running.

J-400 Export

9.6 J-480 Air Controls Diagram

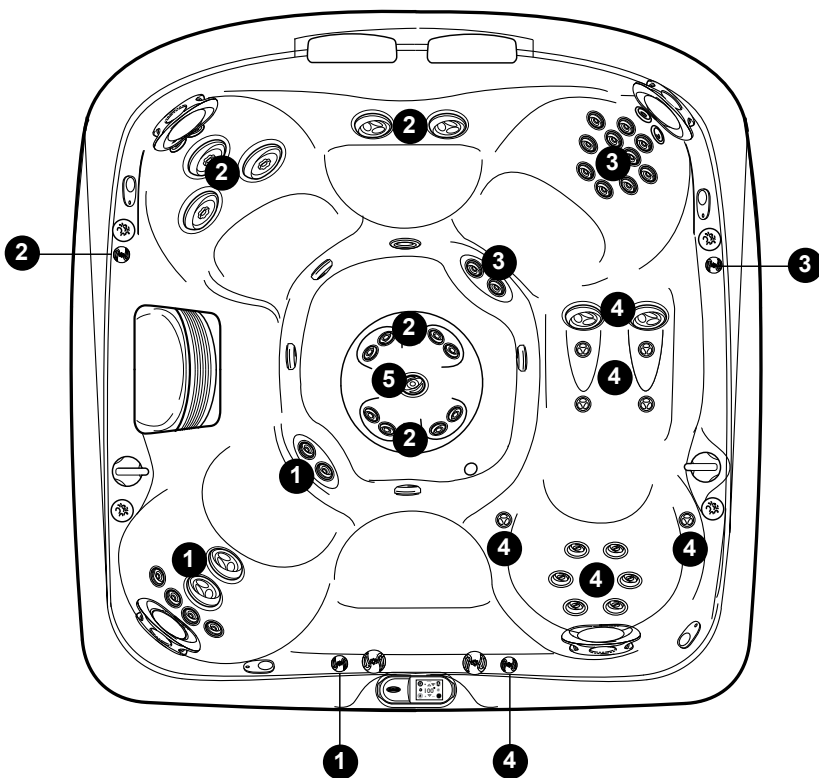

Air Controls Operation

- Rotate air controls 1-4 to add air to designated jet groups.
- Center footwell IX Jet (5) draws air at all times when jets pump is running. This jet has no air control.

9.7 J-470 Spa Features

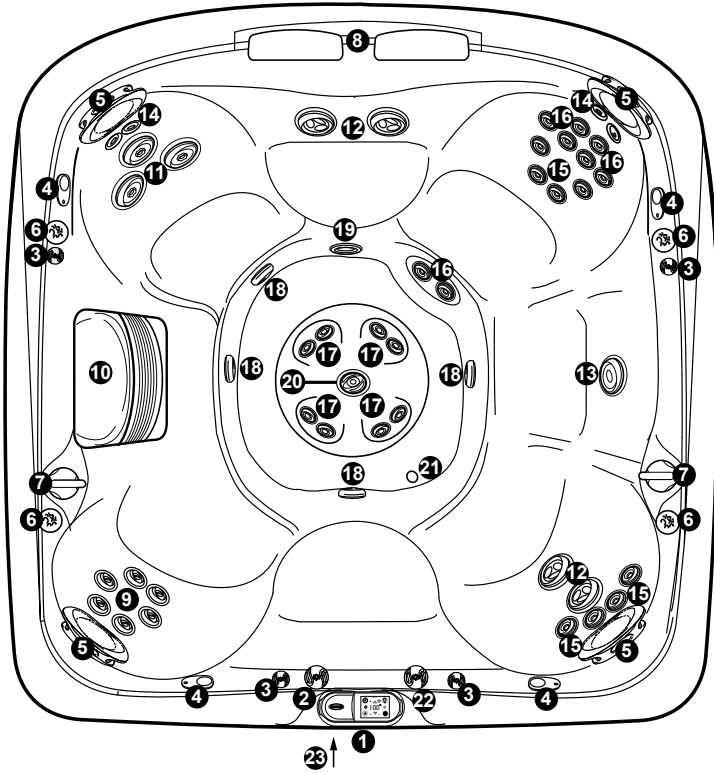

- | | |
|---|--|
| 1. ProTouch™ Control Panel | 12. FX Large Rotational Jets (4 ea.) |
| 2. Waterfall Control Valve | 13. FX Large Jet (1 ea.) |
| 3. Air Control Valves (4 ea.) Introduce Air to Specified Jet Groups | 14. NX2 Jets (4 ea.) |
| 4. Optional Audio System Speakers (4 ea.) | 15. FX Jets (10 ea.) |
| 5. Adjustable Pillows (4 ea.) | 16. FX Rotational Jets (6 ea.) |
| 6. Lighted Cup Holders (4 ea.) | 17. FX Small Jets (8 ea.) |
| 7. Massage Selectors (2 ea.) Controls Specified Jet Groups | 18. Footwell Filter Suction Covers (4 ea.) |
| 8. Waterfalls (2 ea.) | 19. Waterfall Filtration Return |
| 9. RX Jets (6 ea.) | 20. Lighted IX Jet |
| 10. Filter/Skimmer Grill | 21. Gravity Drain/Heater Input/CLEARARRAY Return Fitting |
| 11. MX2 Jets (3 ea.) | 22. Lighted IX Jet Flow Control Valve |
| | 23. Optional BLUEWAVE® Audio System |

Spa features subject to change without notice

J-400 Export

9.8 J-470 Massage/Waterfall Selector Diagram

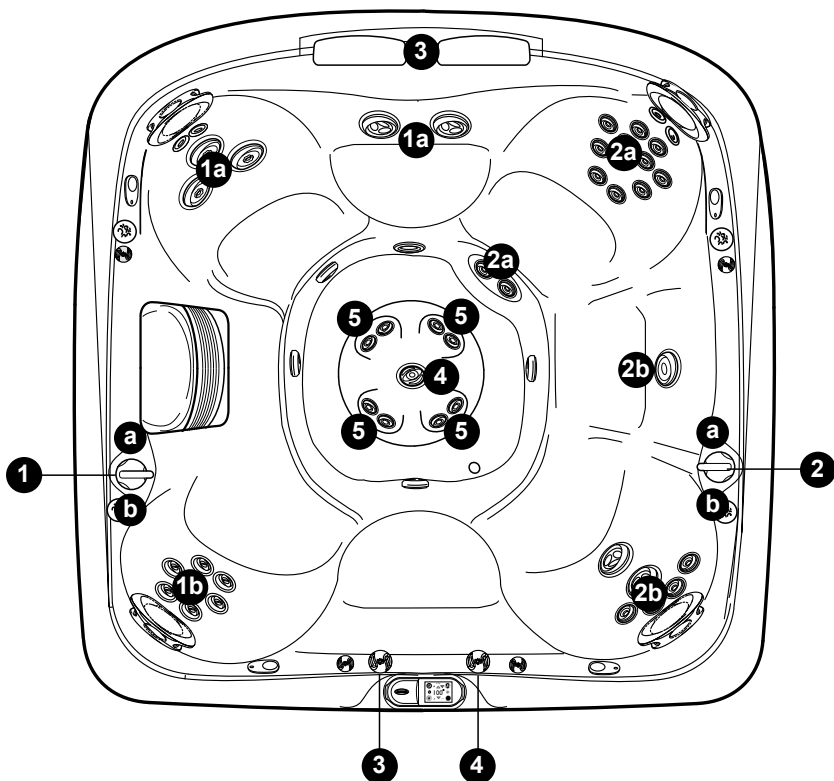

Massage Selectors (1-2)

- Massage selector 1 diverts jets pump N° 1 output between jet groups 1a-1b.
- Massage selector 2 diverts jets pump N° 2 output between jet groups 2a-2b.

Waterfall Selector (3)

- Waterfall selector 3 controls circulation pump output to waterfalls.

IX Jet Flow Control Valve (4)

- Valve (4) controls output to footwell IX Jet when jets pump N° 2 is running.

Jets Without Massage Selector Controls (5)

- Jets (5) are always on when jets pump N° 1 is running.

9.9 J-470 Air Controls Diagram

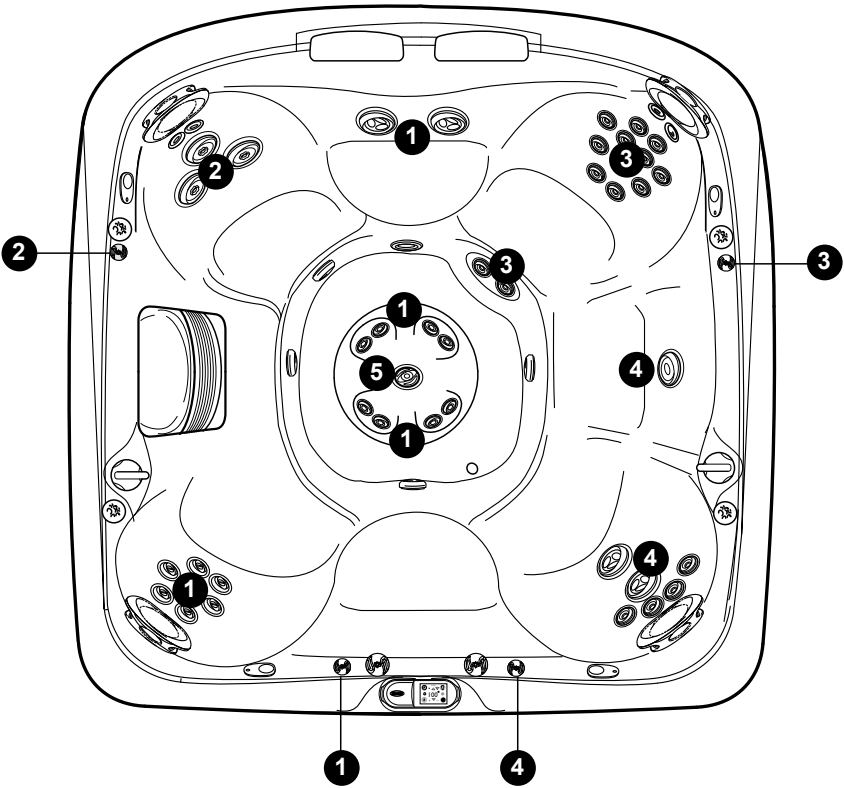

Air Controls Operation

- Rotate air controls 1-4 to add air to designated jet groups.
- Center footwell IX Jet (5) draws air at all times when jets pump is running. This jet has no air control.

J-400 Export

9.10 J-425 Spa Features

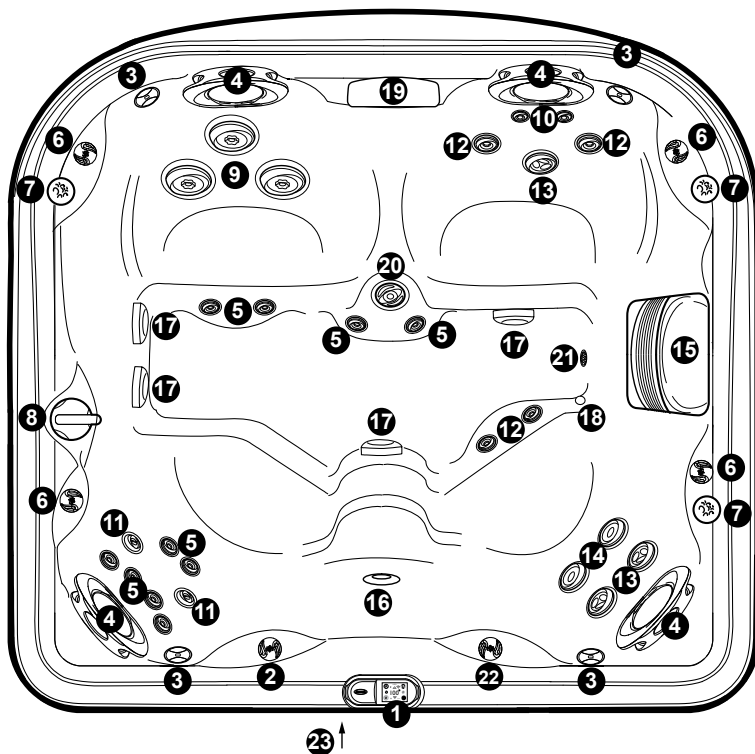

- | | |
|--|---|
| 1. ProTouch™ Control Panel | 12. FX Rotational Jets (4 ea.) |
| 2. Waterfall Control Valve | 13. FX2 Large Rotational Jets (3 ea.) |
| 3. Optional Audio System Speakers
(4 ea.) | 14. FX Large Jets (2 ea.) |
| 4. Adjustable Pillows (4 ea.) | 15. Filter/Skimmer Grill |
| 5. FX Jets (10 ea.) | 16. Underwater Light |
| 6. Air Control Valves (4 ea.) Introduce Air
to Specified Jet Groups | 17. Footwell Filter Suction Covers (4 ea.) |
| 7. Lighted Cup Holders (3 ea.) | 18. Gravity Drain/Heater Input/CLEARRAY
Return Fitting |
| 8. Massage Selector (1 ea.) Controls
Specified Jet Groups | 19. Waterfall |
| 9. MX2 Jets (3 ea.) | 20. Lighted IX Jet |
| 10. NX2 Jets (2 ea.) | 21. Waterfall Filtration Return |
| 11. RX Jets (2 ea.) | 22. Lighted IX Jet Flow Control Valve |
| | 23. Optional BLUEWAVE® Audio System |

Spa features subject to change without notice

9.11 J-425 Massage/Waterfall Selector Diagram

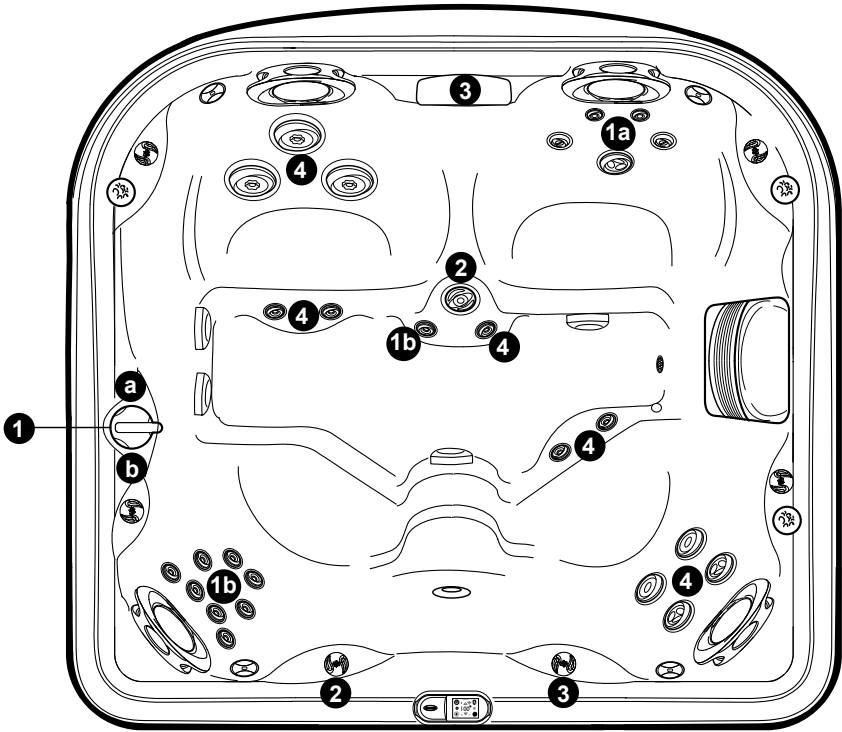

Massage Selector (1)

- *Massage selector 1 diverts jets pump N° 1 output between jet groups 1a-1b.*

IX Jet Flow Control Valve (2)

- *Valve (2) controls output to footwell IX Jet when jets pump N° 1 is running.*

Waterfall Selector (3)

- *Waterfall selector (3) controls circulation pump output to waterfall.*

Jets Without Massage Selector Controls (4)

- *Jets (4) are always on when jets pump N° 2 is running.*

J-400 Export

9.12 J-425 Air Controls Diagram

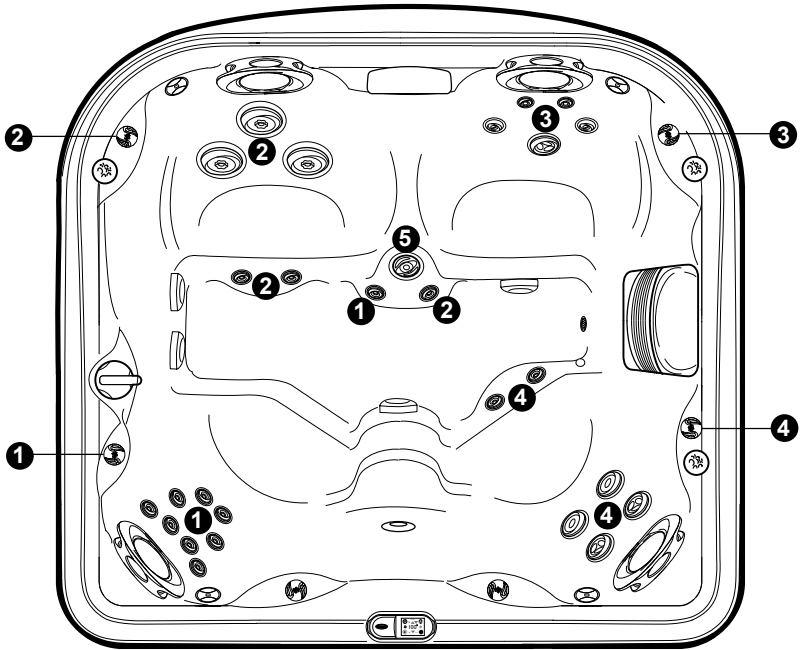

Air Controls Operation

- Rotate air controls 1-4 to add air to designated jet groups.
- Center footwell IX Jet (5) draws air at all times when jets pump is running. This jet has no air control.

9.13 J-415 Spa Features

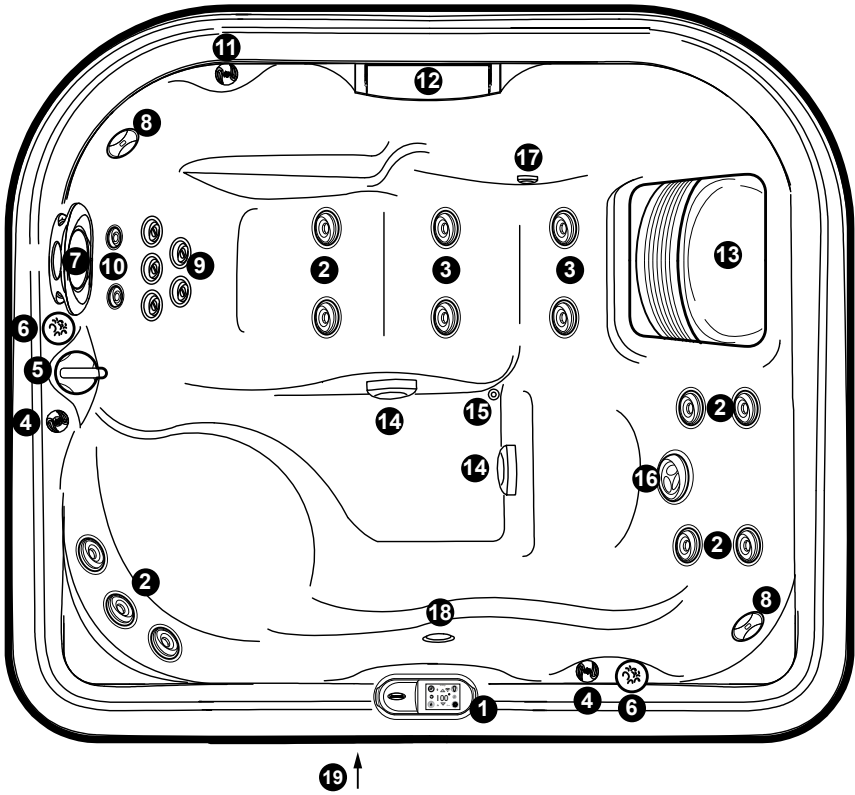

- | | |
|---|--|
| 1. ProTouch™ Control Panel | 11. Waterfall Control Valve |
| 2. FX Jets (9 ea.) | 12. Waterfall |
| 3. FX Rotational Jets (4 ea.) | 13. Filter/Skimmer Grill |
| 4. Air Control Valves (2 ea.) Introduce Air to Specified Jet Groups | 14. Footwell Filter Suction Covers (2 ea.) |
| 5. Massage Selector (1 ea.) Controls Specified Jet Groups | 15. Gravity Drain/Heater Input/CLEARRAY Return Fitting |
| 6. Integrated Cup Holders (2 ea.) | 16. FX Large Rotational Jet (1 ea.) |
| 7. Adjustable Pillow | 17. Waterfall Overflow |
| 8. Optional Audio System Speakers (2 ea.) | 18. Underwater Light |
| 9. RX Jets (5 ea.) | 19. Optional BLUEWAVE® Audio System |
| 10. NX2 Jets (2 ea.) | |

Spa features subject to change without notice

J-400 Export

9.14 J-415 Massage/Waterfall Selector Diagram

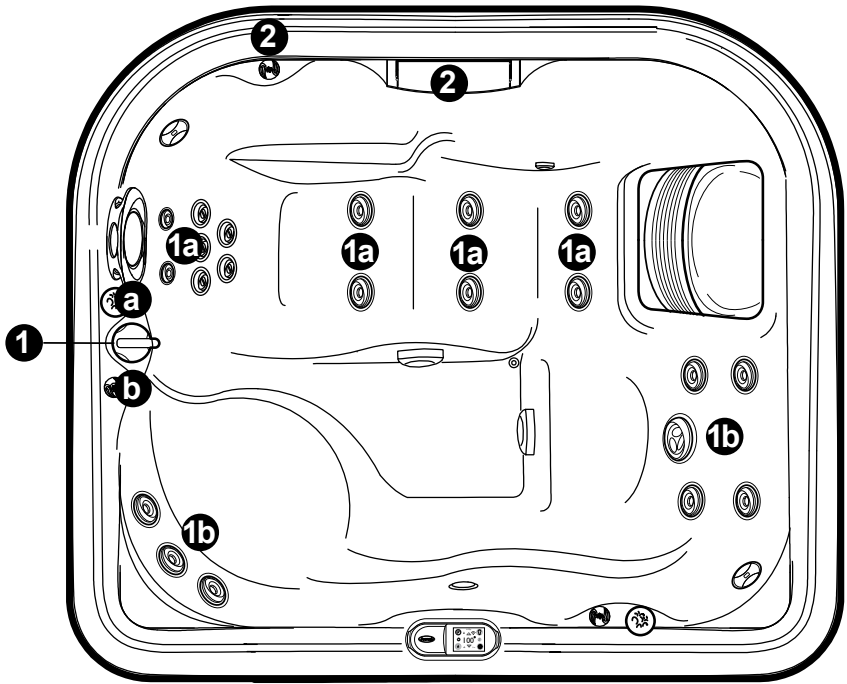

Massage Selector (1)

- *Massage selector 1 diverts output between jet groups 1a-1b.*

Waterfall Selector (2)

- *Waterfall selector 2 controls circulation pump output to waterfall.*

9.15 J-415 Air Controls Diagram

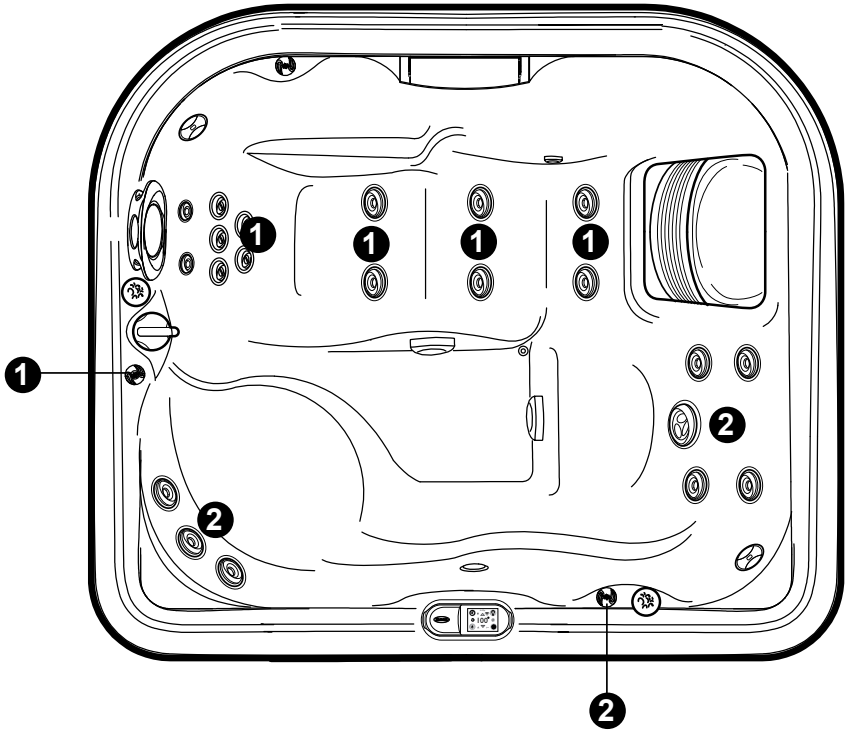

Air Controls Operation

- *Rotate air controls 1-2 to add air to designated jet groups.*

J-400 Export

10.0 Registration and Start-up

10.1 Start-up Sequence

During the start-up sequence, the welcome screens will appear, Figure 10.1a. Then a blow out cycle will begin, page 51. After the cycle ends, the hot tub will either display the Registration Menu or the Home Menu. **Note:** The start up menu will time out after approximately 3 seconds.

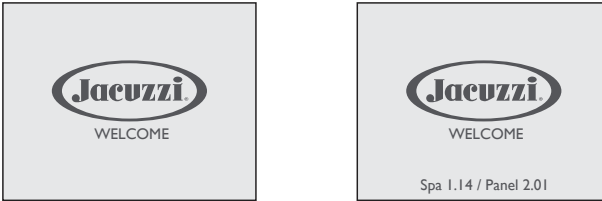

Figure 10.1a

10.2 Register Your New Spa

Registering your spa is important in order to validate your warranty. To register your spa you need to have your spa serial number. The best time to retrieve the serial number is when the spa is being connected. You must register your spa via the internet at www.Jacuzzi.com.

Note: A passcode is only given for North American models only.

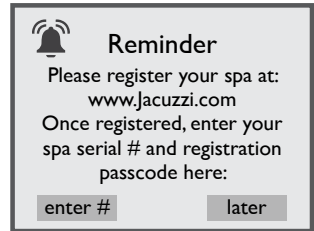

Figure 10.2a

Follow these steps to register your spa.

1. Using your home computer or other device, connect to the internet.
2. Go to www.Jacuzzi.com website to register your spa.
3. Click **Outdoor Hot Tubs**
4. Click **For Owners**
5. Click **Warranty and Manuals**
6. Click **Warranty Registration**
7. Enter your serial number.

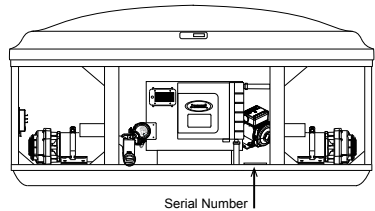



Figure 10.2b

Keep a record of your serial number and passcode for any future reference. Write that information below.

Serial Number: _ _ _ _ _

Once you register your spa online, you can then enter the registration information into the control panel.

Note: If a number is entered wrong you can tap  to move backwards.

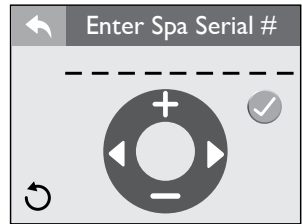

1. From the registration screen, Figure 10.2a, tap **enter #** to enter the spa serial number.
2. Input the 9-digit serial number, Figure 10.2c. If your serial number begins with a letter, use the **-** or **+** buttons until the letter is displayed.
3. Tap  to enter and save the information.

Figure 10.2c

10.3 ProTouch™ Control Panel

The new J400 ProTouch system makes operating your spa a breeze. You can navigate through the menus and sub-menus with ease. Simply touch the icons on the LCD display to begin operating your new Jacuzzi spa.

A. Home Menu Control Buttons



The Home Menu, Figure 10.3a, provides access to spa functions and programming. Operation is made easy by the interactive control panel. If there is no activity for 5 minutes, the LCD display will time-out into a sleep mode. To reactivate the display, just tap the display screen. When a feature is on, the button will have a blue inner glow.



Figure 10.3a



= **Temperature Control:** Allows you to adjust the set temperature of the spa:

- Increase the temperature by tapping  in 0,5°C (1°F) increments.
- Decrease the temperature by tapping  in 0,5°C (1°F) increments.

Note: The temperature range for the spa is 18.33 to 40°C (65 to 104°F). To activate the **Extended Temperature feature** that allows the spa to reach 41°C (106°F), see page 74.



= **Jet Button:** Tap to access the menu to operate the jets pump, page 41.

J-400 Export



= **Light Button:** Tap to access the menu to operate the lighting options, page 42.



= **CLEARRAY Button:** Tap to activate the **CLEARRAY** on demand feature, page 45.



= **Settings Button:** Tap to access the programming and setting menus, page 47.



= **Music Button:** Tap to access the menu to operate the audio system and settings, page 45.

Note: If the spa does not have the stereo option, there will not be a button on the control panel.



= **Error Indicator Icon:** Displays when there is an error message that needs to be addressed. The icon will also appear under the Temperature reading as a reminder, page 71. Tap to view the condition that requires attention.



= **Invert Button:** Tap to invert the display image.



= **Heater ON icon:** Will display when the heater is on.



= **Lock Button:** Displays when one of the lock modes is enabled, page 55.



= **Wi-Fi icon:** Will display when the Wi-Fi feature is on page 54.

6:45p

= **Time Indicator:** The time will always be shown when the Home Menu is displayed. The appearance will vary depending on whether the clock is set to a 12-Hour or 24-Hour configuration, page 56. The default setting is 12-Hour.

Note: The time does NOT automatically adjust for daylight saving time. The time must be manually adjusted.

11.0 Operating Instructions

11.1 ProTouch™ Control Panel

Your Jacuzzi spa is equipped with a ProTouch control panel; massage selectors, and air control knobs located on the top rim of the spa (pages 23-37). These controls let you operate many of the special functions of your Jacuzzi spa.

11.2 Activating the Jets Pumps

From the Home Menu, (Figure 11.2a), tap  to enter the Jets Pump Submenu. The panel will display the Jets Pump Submenu (Figure 11.2b).

Note: Once you enter the Jets Pump Submenu, all the pumps will activate. You can turn off the jets pump by tapping the jets pump button.



Figure 11.2a

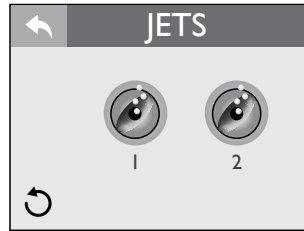

Figure 11.2b



1

= **Jets Pump 1 Button**



2

= **Jets Pump 2 Button (If applicable)**



3

= **Jets Pump 3 Button (If applicable)**



= **Back Button:** Tap to go back to the previous menu.



= **Invert Button:** Tap to invert the display image.

1. Tap the Jets 1 button to turn the pump on and off.
2. Tap the Jets 2 button to turn the pump on and off.
3. Tap the Jets 3 button to turn the pump on and off.
4. When a jets pump is on, the button will have a blue inner glow.



JETS ICON WHEN ON





JETS ICON WHEN OFF

Note: Auto Turn Off — Anytime a pump has been manually turned on, it will automatically turn off after approximately 20 minutes. If at this time you desire more jet operation you may simply turn the pump(s) back on.

J-400 Export

11.3 Lights Menu

From the Home Menu, (Figure 11.3a), tap  to enter the Light submenus. The LCD screen will display the Light Submenu (Figure 11.3b). From this menu you can control the hot tub lighting. When you tap  to enter the submenu, the lights will turn on, if not on already, in a color blending mode. Default settings are brightness level at 0 and speed setting of 0.

Note: The lights automatically turn off after 2 hours. They can be reactivated if needed.



Figure 11.3a

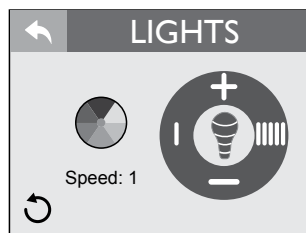

Figure 11.3b



= **Brightness Up Button:** Tap to raise the intensity of the lights to the maximum level of 5. The intensity levels are as follows: 5 = 100%, 4 = 80%, 3 = 60%, 2 = 40% and 1 = 20%, 0 = 0%.



= **Brightness Down Button:** Tap to lower the intensity of the lights to the minimum level of 0.



= **Intensity Indicator:** Displays the current intensity level of the lights by the number of bars filled in. This will only work with the solid color option. If the blending mode is on, the light bulb is grayed out. The range is from 0 to 5.



= **Speed Control Button (Increase):** Tap to increase the blending speed, of the colors, to the maximum speed of 5. The speed settings are as follows: 5 = every 5 secs, 4 = every 10 secs, 3 = every 15 secs, 2 = every 30 secs and 1 = every 60 secs.



= **Speed Control Button (Decrease):** Tap to decrease the blending speed, of the colors, to the minimum speed of 0.

Speed: 1

= **Speed Selector Icon:** Tap  or  to select the blending speed for the light colors.



= **Color Selector:** Tap a color to select a single color.



= **Back Button:** Tap to go back to the previous menu.





= **Invert Button:** Tap to invert the display image.

11.4 Music Menu

Models equipped with the optional Audio System offer an enhanced spa experience. The BLUEWAVE 2.0 Wireless Audio System works with most Bluetooth wireless devices. An auxiliary device can be connected, via a 3.5 mm plug cable, located behind the front cabinet panel, if a Bluetooth device is not available. These models also include four high fidelity spa engineered speakers for unsurpassed sound quality and long-life, and an integrated powered subwoofer for a superb acoustical sound.

Note: If the spa does not have the stereo option, there will not be a button on the control panel.

To access the Music Menu, tap  , Figure 11.4a. The display will change to Figure 11.4b. Once you enter the Music Menu, tap the power button to turn the stereo on. Your connected electronic device, Bluetooth or auxiliary, provides the audio entertainment.



WARNING: RISK OF ELECTRICAL SHOCK HAZARD EXISTS AND EQUIPMENT DAMAGE! Never install or remove electrical devices while hands are wet or while sitting partially immersed or fully immersed in spa!



Figure 11.4a



Figure 11.4b



= **Power Button:** Tap to turn the stereo on and off.



= **Bluetooth Settings:** Tap to use your Bluetooth device with the stereo. This is the default setting.



= **Auxiliary Settings:** Tap to use your Auxiliary device with the stereo.



= **Volume Up:** Tap to increase the volume. The range is from 0 to 30 in increments of 1.



= **Volume Down:** Tap to decrease the volume. The range is from 0 to 30 in increments of 1.



= **Forward:** Tap to advance forward through tracks.



= **Rewind:** Tap to move back through tracks.

J-400 Export

 = **Pause/Play:** Tap to pause and play tracks.

Track Name = **Artist Track:** Will display the artist and track information, if it is available. If the information is not available this part will be blank. If the information provided is too long, the maximum number of characters will be display follow by dots (“...”).

 = **Audio Settings:** Tap to access the audio submenu.

Vol: 30 = **Volume:** Displays the current volume level from 0 to 30.

 = **Back Button:** Tap to go back to the previous menu.

 = **Invert Button:** Tap to invert the display image.

11.5 Connecting the BLUEWAVE® System with your Bluetooth® device

To bridge a connection between the BLUEWAVE 2.0 Wireless Audio System and your Bluetooth® device, follow the steps below.

Note: The BT icon cannot be selected manually unless a Bluetooth connection is established with your device. If you experience a connection problem with your Bluetooth device, make sure that the Bluetooth antenna is secure and located at the highest point within the equipment bay.

1. Tap the music icon on the control panel screen then touch the power button located on the top right to turn on the stereo.
2. From your Bluetooth device, make sure that the Bluetooth setting is ON.
3. Follow the pairing instructions for your Bluetooth device and connect to the “BLUEWAVE” device that appears on your screen.
4. Once the connection is established, the Bluetooth “BT” icon on the screen will be highlighted confirming the connection.
5. If asked for a password, enter the password “0000” and then connect.
6. If the pairing process is successful, your Bluetooth device will show “Connected” right next to “BLUEWAVE.” The Bluetooth icon will be highlighted.

11.6 Audio Settings Menu

To enter the Audio Settings Menu, tap > from the Music submenu, Figure 11.6a. The display will change to Figure 11.6b. The Audio Settings Menu offers an enhanced audio experience by providing a custom or preset bass and treble settings.



Figure 11.6a

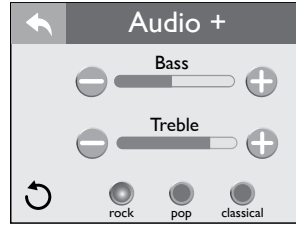







Figure 11.6b

 = **Bass Adjustment:** Slide from side to side to adjust the Bass range from -5 to 5. This feature can be used to create a custom sound.

 = **Treble Adjustment:** Slide from side to side to adjust the Treble range from -5 to 5. This feature can be used to create a custom sound.

 = **Rock Preset:** Tap to activate the “Rock” music audio setting. “Rock” has a 1 Bass and 3 Treble preset setting. When not in use it will be grayed out; if it is in use the button will be highlighted, Figure 11.6b.

 = **Pop Preset:** Tap to activate the “Pop” music audio setting. “Pop” has a -1 Bass and -2 Treble preset setting. When not in use it will be grayed out; if it is in use the button will be highlighted, Figure 11.6b.

 = **Classical Preset:** Tap to activate the “Classical” music audio setting. “Classical” has a 1 Bass and 1 Treble preset setting. When not in use it will be grayed out; if it is in use the button will be highlighted, Figure 11.6b.

 = **Back Button:** Tap to go back to the previous menu.

 = **Invert Button:** Tap to invert the display image.

11.7 CLEARRAY on Demand

The CLEARRAY on demand feature activates the water purification system for a period of 1-hour. Tap  to turn the system on. During this time the circulation pump and the CLEARRAY unit are on. The button will have a blue inner glow when this feature is on.

Note: When the CLEARRAY system is on due to a programmed or scheduled setting the feature cannot be turned off.

J-400 Export

11.8 Adjusting Jet Flow

The water flow to certain jets in your spa can be increased or decreased by rotating the outside jet face.

Note: Always keep at least 6 adjustable jets open at all times.



11.9 Adjusting PowerPro™ MX2 Jets

Tilt PowerPro MX2 Jet nozzle to angle of choice as desired.

Rotate nozzle clockwise to reduce flow volume from jet or rotate counterclockwise to increase flow volume.

Note: Always keep at least 6 adjustable jets open at all times.



11.10 Adjusting RX Jets

Rotate the outside jet face clockwise to decrease or shut off water flow. Turn counterclockwise to turn on or increase water flow.

Note: Always keep at least 6 adjustable jets open at all times.



11.11 WaterColour™ Waterfall Control

Turn waterfall control valve (pages 23-37) counterclockwise to increase waterfall output. Turn control valve clockwise to decrease or turn off waterfalls.

Note: When the waterfall is in the OFF position, some water may still flow through. This is considered normal.



11.12 Air Controls

Certain jet systems have their own air control. Each control introduces air into the water lines that supply that specific jet group (pages 23-37). Simply rotate any air control clockwise to open or rotate counterclockwise to close. To minimize heat loss, all air controls should be closed when the spa is not in use.

Note: Certain jets may draw air even though they are closed. This is considered normal.



11.13 Selecting the Desired Massage Action

Your Jacuzzi spa is equipped to allow you to customize the massage action you desire. Each model incorporates a massage selector that allow you to customize the massage and performance by diverting water between various jet systems. Simply turn massage selector to position A (Combo), B, or C to divert water pressure to various jet groups.

Note: The massage selector valve(s) is designed to operate in positions A (Combo), B, and C for optimum performance. It is considered normal for sound levels within the valve to vary between positions due to the large amounts of water flowing through it. For optimum filtration benefits, leave the valve in position A when spa is covered. Select position B or C for maximum jet performance during spa use.

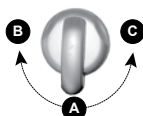

11.14 Indicator Light

The indicator light located on the front cabinet panel of the spa is an early detection system that will notify you when the spa needs immediate attention. A solid white light indicates that all operations are normal. A solid red light indicates that immediate attention is required to clear or fix an error code. For a detailed explanation refer to page 71. Always insist on genuine Jacuzzi replacement parts.



12.0 Programming and Operation Instructions

Your Jacuzzi spa is equipped with setting menus that allow you to program and activate different components of the spa. With our ProTouch control panel, programming your spa has never been easier. In the sections that follow, we will guide you through the process of programming the spa to fit your personal comfort. Tap  to enter the Settings Menu.



Figure 12.0a

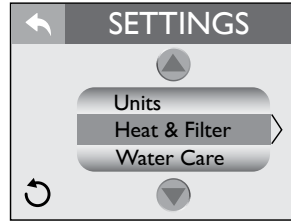

Figure 12.0b

Heat & Filter = **Heat and Filter:** Provides access to the heating and filtration programming, page 48.

Water Care = **Water Care:** Provides access to the water care programming, page 51.

WiFi = **Wi-Fi:** Provides access to the Wi-Fi programming, page 54.

Lock = **Lock:** Provides access to the spa lock programming, page 55.

Time & Date = **Time and Date:** Provides access to the time and date programming, page 56.

Language = **Language:** Provides access to the language programming, page 57.

Units = **Units:** Provides access for the temperature display in **F°** or **C°**, page 57. Default setting is **F°**.

J-400 Export



= **Back Button:** Tap to go back to the previous menu.



= **Invert Button:** Tap to invert the display image.



= **Scroll Buttons:** Scroll up and down to view the selections available.

12.1 Programming the Heating Mode

Your Jacuzzi spa is equipped with 3 modes of heating, Figure 12.1a. An automatic mode called “Auto,” where the spa’s temperature is maintained at all times. An energy saving heating cycle called “Econo.” A mode that will only activate the heater during the daytime called “Day” mode.

Note: The heater will activate when the temperature drops 2° from the set temperature.

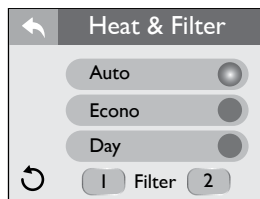







Figure 12.1a

 Indicates that the feature is active.  Indicates that the feature is not active.

From the Settings Menu, tap  or  to highlight the “Heat & Filter” menu tab in Orange. Tap  to enter the menu. Then select one of the heating settings.

A. Auto heating:

1. When programmed to “Auto,” the spa will maintain the water temperature to the set temperature. Heating will occur when necessary.
2. To select this mode, tap  next to the “Auto” icon.

B. Econo heating:

1. This is an energy saving heating program that allows the spa to heat during non-peak hours. When programmed to “Econo,” the spa will only be allowed to heat the water between 5:00 PM to 7:00 AM every day of the week. The hours cannot be adjusted.
2. To select this mode, tap  next to the “Econo” icon.

C. Day heating:

1. When programmed to “Day,” the spa will only be allowed to heat the water between 7:00 AM to 5:00 PM every day of the week. The hours cannot be adjusted.
2. To select this mode, tap  next to the “Day” icon.

12.2 Programming the Primary Filter

To access the “Primary Filter” feature, tap **1** from the Heat & Filter menu, Figure 12.2a, to enter the “Primary Filter” programming, Figure 12.2b.

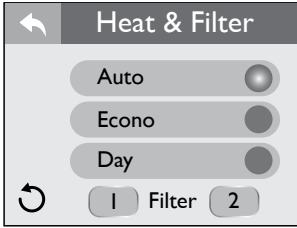

Figure 12.2a

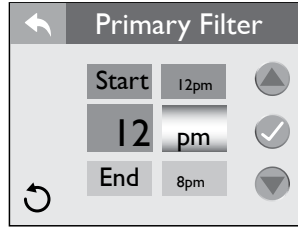

Figure 12.2b

During a primary filtration, the circulation pump, CLEARRAY and ozone unit (if applicable) are activated. The factory default cycle starts at 12:00 AM and last for 8 hours. If you elect to keep this setting, then you can skip this section.



In extreme bitter cold weather we recommend you program the circulation pump to run 24 hours. Refer to the "Winterizing" section on page 65.

Any time the circulation pump runs outside of a program cycle, e.g. for heating, that run time will be deducted from the next primary filter cycle. For example, the primary filter cycle is set to 8 hours every 24 hours but the circulation pump comes on for 2 hours to heat the water after the cycle has finished. The next primary filter cycle will only be for 6 hours not 8 hours.

A. To change the default cycle:

When you enter the menu, “Start” and “12” will be highlighted.

1. Tap ▲ or ▼ to change the hour in 1-hour increments. To switch from “AM” to “PM” you must round a 12-Hour period.
2. Tap ✓ to accept the change.
3. Tap **End** to program the end time for the cycle.
4. Tap the hour block to change the end time.
5. Tap ▲ or ▼ to change the hour in 1-hour increments. To switch from “AM” to “PM” you must round a 12-Hour period.
6. Tap ✓ to confirm and save your changes.
7. Tap ↶ to return to the Heat & Filter Menu. Tap again to return to the Settings Menu.

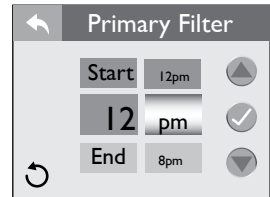

Figure 12.2c

J-400 Export

Summer Logic: In warm weather, the water temperature in the spa may exceed the set temperature. This condition may occur due to heat transference from the filter/circulation pump and jets pumps. If the water temperature is higher than 95°F (35°C) and rises two degrees above the set temperature, a “Summer Logic” condition occurs that deactivates the filter/circulation pump and CLEARRAY®. This safety feature cannot be altered! The filter/circulation pump and CLEARRAY® will remain off until the water temperature cools to the set temperature (except between 9am-11am when the filter/circulation pump runs for it’s mandatory 2 hour cycle.) To help prevent a “Summer Logic” condition, it may be necessary to reduce filter/circulation pump cycles run times in warm weather.

12.3 Programming the Secondary Filter

To access the “Secondary Filter” feature, tap **2** from the Heat & Filter Menu, Figure 12.3a, to enter the “Secondary Filter” programming, Figure 12.3b.

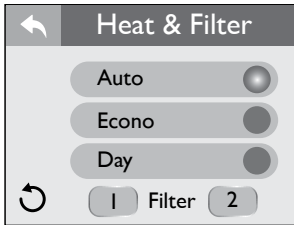

Figure 12.3a

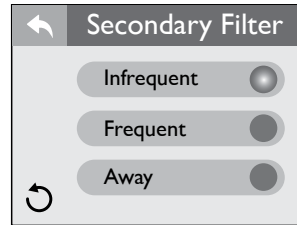

Figure 12.3b

During a secondary filtration, the Jets Pump 1 is activated. There are 3 cycles you can select from, Figure 12.3b. The factory default cycle is “Away Mode.” If you elect to keep this setting, then you can skip this section.

● Indicates that the feature is active. ● Indicates that the feature is not active.

A. To change the Secondary Filter cycle:

1. **Away Mode:** Secondary Filtration is disabled. To activate this mode, tap ● next “Away.” This is the factory default setting.
2. **Infrequent Mode:** Activates two cycles at 8:00 PM and 8:00 AM **every other day**. Each cycle will last 10 minutes for a total of 20 minutes every other day. To activate this mode, tap ● next to “Infrequent.” Time and duration cannot be altered.
3. **Frequent Mode:** Activates two cycles at 8:00 PM and 8:00 AM **every day**. Each cycle will last 10 minutes for a total of 20 minutes every day. To activate this mode, tap ● next to “Frequent.” Time and duration cannot be altered.
4. Tap ↶ to return to the Heat & Filter Menu. Tap again to return to the Settings Menu.

12.4 Cleanup Cycle

The cleanup cycle occurs once per day at 12:00 pm (noon) for 2 minutes. This is not user programmable. The Jets Pump 1 and the Circulation Pump will turn on for one minute and then shut off. Then Jets Pump 2 will turn on and run for 1 minute then shut off. Lastly, Jets Pump 3 will turn on and run for 1 minute then shut off. The feature can be deactivated by turning off the corresponding jets pump that is running.

12.5 Blow-Out Cycle

This cycle will purge the air from the plumbing lines normally caused by draining and filling the spa. The Jets Pump 1 and the Circulation Pump will turn on for 1 minute and then shut off. Then Jets Pump 2 will turn on and run for 1 minute then shut off. Lastly, Jets Pump 3 will turn on and run for 1 minute then shut off. The feature can be deactivated by turning off the corresponding jets pump that is running. This cycle will **only** occur at start up and after exiting a service lock.

12.6 Water Care Programming

Water care is crucial to maintaining a healthy and clean spa. The CLEARRAY water purification system leads the way by sanitizing the water using a UV light bulb. Your spa can be programmed to remind you when to check and replace certain components.

From the Settings Menu, tap ▲ or ▼ to highlight the “Water Care” menu tab in Orange, Figures 12.6a and 12.6b. Tap **Water Care** to the enter the menu. Then select one of the features.

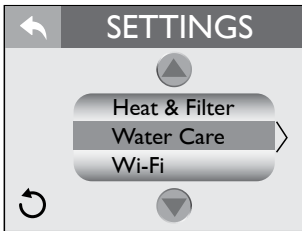

Figure 12.6a

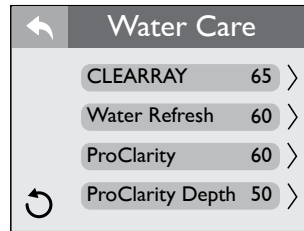

Figure 12.6b

A. Programming the CLEARRAY UV Bulb Timer

The CLEARRAY UV bulb has a life expectancy of 1 year. A timer activates when power is applied and begins a countdown starting at 365 days. Once the timer expires, an error message will appear of the display, the UV bulb must be replaced and the timer needs to be reset. Tap **CLEARRAY 65** > (Figure 12.6b) to enter the Programming Menu.

Note: The days are stored in memory if the power is interrupted.

J-400 Export





1. From the “Water Care” Menu you can to set the CLEARRAY UV bulb timer, Figure 12.6c.
2. Tap  or  to change the days in 10-day increments. The range is from OFF to 365 days. The CLEARRAY UV timer counts down by days not usage.



Figure 12.6c

Note: It is not recommended that this feature be turned OFF. In order to continually have the CLEARRAY system effectively preform its function, it should be program as instructed.

3. Tap  to confirm and save your changes.
4. Tap  to return to the “Water Care” Menu. Tap again to return to the Settings Menu.
5. When the timer expires, a message will appear on the control panel display, Figure 12.6d. The CLEARRAY UV bulb **must be replaced** (page 69) and the timer must be reset. Tap “reset” and follow the instructions above to reset the timer. If you tap “snooze” the message will clear but the error icon  will display and the reminder screen will reappear in 10 days.

B. Programming the Water Change Timer







A programmable “Water Refresh” reminder can be set to remind you when to drain and refill the spa. Tap  60 > (Figure 12.6b) to enter the Programming Menu.

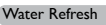

Figure 12.6d

1. From the “Water Care” Menu you can to set the “Water Refresh” timer, Figure 12.6d.
2. Tap  or  to change the days in 30-day increments. The range is from OFF to 180 days.

Note: It is not recommended that this feature be turned OFF. In order to continually maintain the water healthy and clean, in addition to chemical maintenance, it should be program as instructed.

3. Tap  to confirm and save your changes.
4. Tap  to return to the “Water Care” Menu. Tap again to return to the Settings Menu.
5. When the timer expires, a message will appear on the control panel display. The water must be drained and replaced with fresh water. Follow the instructions above to reset the timer. If you tap “snooze” the message will clear but the error icon  will display and the reminder screen will reappear in 10 days. Refer to Section 13.1, page 59, for filter location.

C. Programming the ProClarity/ProClear Filter Timer

A programmable filter timer can be set to remind you when to clean or replace the filters and skimmer bag. Tap **ProClarity 60** > (Figure 12.6b) to enter the Programming Menu.

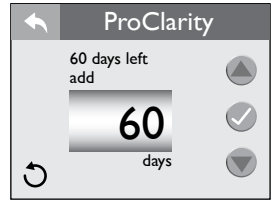

Figure 12.6e

1. From the “Water Care” Menu you can to set the “ProClarity” timer, Figure 12.6e.
2. Tap or to change the days in 10-day increments. The range is from OFF to 180 days.

Note: It is not recommended that this feature be turned OFF. In order to continually maintain clean and working filters, it should be program as instructed.

3. Tap to confirm and save your changes.
4. Tap to return to the “Water Care” Menu. Tap again to return to the Settings Menu.
5. When the timer expires, a message will appear on the control panel display. The filters must be cleaned or replaced. Follow the instructions above to reset the timer. If you tap “snooze” the message will clear but the error icon will display and the reminder screen will reappear in 10 days. Refer to Section 13.1, page 59, for cleaning instructions.

D. Programming the ProClarity Depth Filter Timer

A programmable filter timer can be set to remind you when to replace the ProClarity Depth Filter. Tap **ProClarity Depth 50** > (Figure 12.6f) to enter the Programming Menu.

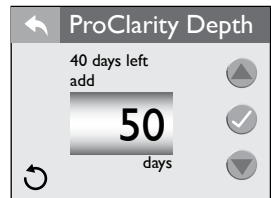

Figure 12.6f



1. From the “Water Care” Menu you can to set the “ProClarity Depth” timer, Figure 12.6f.
2. Tap or to change the days in 10-day increments. The range is from OFF to 90 days.

Note: It is not recommended that this feature be turned OFF. In order to continually maintain clean and working filters, it should be program as instructed.

3. Tap to confirm and save your changes.
4. Tap to return to the “Water Care” Menu. Tap again to return to the Settings Menu.
5. When the timer expires, a message will appear on the control panel display. Follow the previous instructions to reset the timer. The filter must be replaced. Refer to Section 13.1, page 59, for filter location. If you tap “snooze” the message will clear but the error icon will display and the reminder screen will reappear in 10 days.

J-400 Export

12.7 Optional Wi-Fi Setup

From the Settings Menu, tap  or  to highlight the “Wi-Fi” Menu tab in Orange. Tap  to enter the programming options, Figures 12.7a and 12.7b. Make sure you have downloaded the Wi-Fi App for this setup.

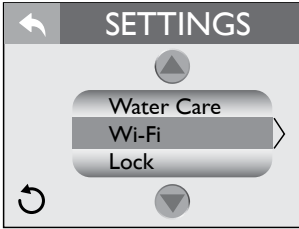

Figure 12.7a





Figure 12.7b

1. You need to follow the instructions from the App in order to connect the Wi-Fi.
2. While the system attempts to connect you will see the, “Spa Wi-Fi Setup in-progress,” Figure 12.7b. When the connection is done the display will read, “Spa Wi-Fi Setup Successfully Connected,” Figure 12.7c.





Figure 12.7c

If the Wi-Fi connection setting should need to be updated or connected to a new router, follow the steps below.

1. From the “Settings” menu, tap  (Figure 12.7a) to enter the menu.
2. Tap . The display will change to “Spa Wi-Fi Setup In-progress” and the reset button will be highlighted in Orange.
3. Tap  again. This will clear the current data and allow the spa to connect to the new data.
4. Reconfigure and setup your spa by following the instructions from the app.

12.8 Locking the Spa

From the Settings Menu, tap ▲ or ▼ to highlight the “Lock” menu tab in Orange. Tap  (Figure 12.8a) to enter the programming options, Figures 12.8a and 12.8b. You can prevent users from changing certain features of the spa. When a lock feature is active, the lock icon  will appear on the Main Menu. When you enter the “Lock” Menu, if one of the three settings is locked, it will be highlighted Orange.

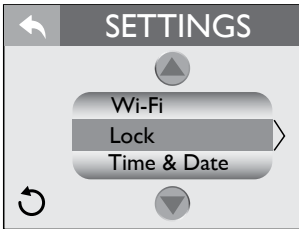

Figure 12.8a

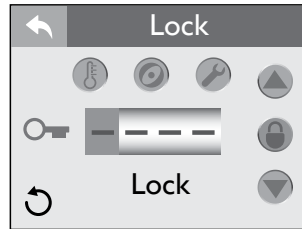









Figure 12.8b



A. Temp Lock (Figure 12.8b):

1. Tap  to lock the temperature feature.
2. Tap  (the first block) to select a number. Use ▲ or ▼ to select a number from 0-9. Then move on to the next number until a four-digit code has been selected.
3. Tap  to activate the locking feature.
4. The adjust temperature feature is disabled, but the spa will still perform all scheduled tasks.
5. Tap  to return to the “Settings” Menu.

B. Spa Lock (Figure 12.8b):

1. Tap  to lock the spa. When this feature is activated both the spa and temperature lock are highlighted Orange.
2. Tap  (the first block) to select a number. Use ▲ or ▼ to select a number from 0-9. Then move on to the next number until a four-digit code has been selected.
3. Tap  to activate the locking feature.
4. All activation and adjustment features are disabled but the spa will still perform all scheduled tasks.
5. Tap  to return to the “Settings” Menu.

C. Service Lock (Figure 12.8b):



1. Tap  to lock the spa. When this feature is activated all the lock buttons highlighted Orange.
2. Tap  (block) to select a number. Use ▲ or ▼ to select a number from 0-9. Then move on to the next number until a four-digit code has been selected.
3. Tap  to activate the locking feature.

J-400 Export

4. All spa functions are locked to allow for a temporary service mode for filter cleaning.

Note: This mode has a time out of 2 hours. The spa should not be left in this lock mode for an extended period. Especially in colder climate or when freezing conditions exist.

D. To Unlock (Figure 12.8c):

1. Enter the Lock menu. The type of lock that is active will already be highlighted in Orange.
2. Tap  (the first block) to start entering the code. Then move on to the next number until the four-digit unlock code has been entered.
3. Tap  to unlock.
4. Tap  a few times to exit the menu.

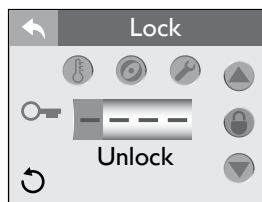





Figure 12.8c

Note: A default passcode can be used in case the original passcode is lost or forgotten. The code “0772” will unlock the locked setting.

12.9 Programming the Time and Date

From the Settings Menu, tap  or  to highlight the “Time & Date” menu tab in Orange. Tap  to enter the programming options, Figures 12.9a and 12.9b.

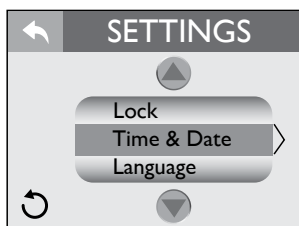

Figure 12.9a

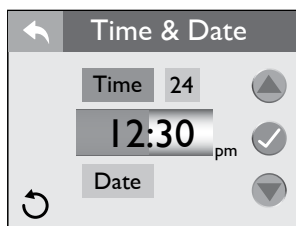











Figure 12.9b

A. To set the time:

The default time setting is a 12-Hour configuration. To choose the 24-Hour configuration, then tap  to change the setting.

1. When you enter the menu,  will be highlighted Orange, Figure 12.9c.
2. Tap the hour block  to program.
3. Tap  or  to change the hour in 1-hour increments. To switch from “AM” to “PM” you must round a 12-Hour period.
4. Tap the minute block  to program.
5. Tap  or  to change the minutes.
6. Tap  to confirm and save your changes.

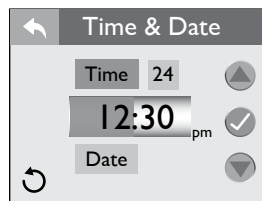

Figure 12.9c

B. To set the date:

Each setting for month, day and year can be set independently.

1. Tap **Date** to program the date, Figure 12.9d.
2. Tap the month block **1 30 2015** to program.
3. Tap ▲ or ▼ to make changes.
4. Tap the day block **1 30 2015** to program.
5. Tap ▲ or ▼ to make changes.
6. Tap the year block **1 30 2015** to program.
7. Tap ▲ or ▼ to make changes.
8. Tap ✓ to save and accept the changes.
9. Tap ↶ to return to the “Settings” Menu.

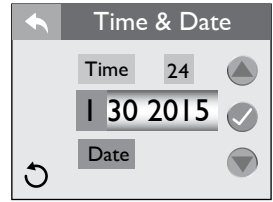

Figure 12.9d

12.10 Programming the Language

From the Settings Menu, tap ▲ or ▼ to highlight the “Language” menu tab in Orange. Tap **Language** to enter the language options, Figures 12.10a and 12.10b.

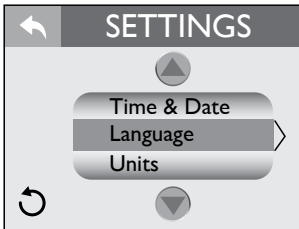

Figure 12.10a

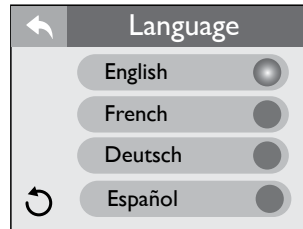

Figure 12.10b

1. There are 4 languages to select from: English, French, Deutsch, and Español. To select a language, tap ● next to the language you want to display, Figure 12.10b.
2. Tap ↶ to return to the “Settings” Menu.

12.11 Units Display

From the Settings Menu, tap ▲ or ▼ to highlight the “Units” Menu tab in Orange. Tap **Units** to enter the selection menu, Figures 12.11a and 12.11b.

1. Tap ● next to the unit of measure that you want to display.
2. Tap ↶ a few times to return to the Main Menu.

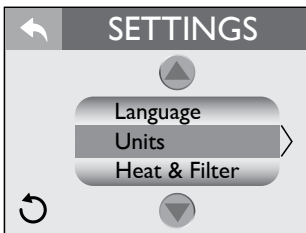

Figure 12.11a

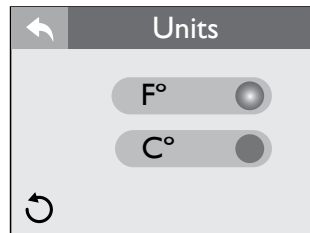





Figure 12.11b

J-400 Export

12.12 System Information

This menu will display the current information for the spa. From the Settings Menu, tap  or  to highlight the “System Information” Menu tab in Orange. Tap  to enter the selection menu, Figure 12.12a. There are no selections that can be made. The menu simply provides information.

System Information	
Water Temp	97 F
HiLimit Temp	99 F
Spa State	Flow
Flow Sensor	Closed
Ambient Temp	<150 F
DIP Switches	0010000000

Figure 12.12a

13.0 Spa Maintenance

Proper and regular maintenance of your spa will help it retain its beauty and performance. Your authorized Jacuzzi dealer can supply you with all the information, supplies, and accessory products you will need to accomplish this.



DANGER: RISK OF SEVERE INJURY OR DROWNING BY ENTRAPMENT!

- Keep hair, loose articles of clothing or hanging jewelry away from suction fittings, rotating jets or other moving components to avoid entrapment that could lead to drowning or severe injury.
- Never use the spa unless all suction guards, filter, filter lid, or skimmer assembly are installed to prevent body and/or hair entrapment.
- Never operate or use the spa if the filter, filter lid, or skimmer assembly are broken or any part of the skimmer assembly is missing. Please contact your dealer or nearest service center for service.
- The suction fittings and suction covers in this spa are sized to match the specific water flow created by the pump(s). If it is necessary to replace the suction fittings, suction covers or pump(s), be sure that the flow rates are compatible and are in compliance with the VGB Safety Act, page 2.
- Never replace a suction fitting or suction cover with one rated less than the flow rate marked on the original suction fitting. Using improper suction fittings or suction covers can create a body or hair suction entrapment hazard that may lead to drowning or severe injury.
- Owners must alert all spa users to the potential risk of Hair, Limb, Body, Evisceration (disembowelment), and Mechanical Entrapment, page 6.

13.1 Cleaning the Filter Cartridges

A reminder message appears on the control panel display after a specified number days to remind you to clean the skimmer filter and to check the polishing bag filter. This reminder must be reset at each filter cleaning interval. Refer to Section 12.6 (page 51) for additional



information and programming details. Your new spa is equipped with an advanced 2-Stage filtration system. Fine debris are filtered by the circulation pump drawing water through the ProClarity™/ProClear™ skimmer and pleated filter cartridges 8 hours (unless programmed otherwise). Large debris are filtered when jets pump 1 is running when the spa is in use or during a programmed filter cycle. These pumps draw water from footwell suction fitting and through a secondary water polishing bag filter and additional filter.

A. Cleaning the filters and filter bag

To ensure optimum performance:

1. The ProClarity™ filter cartridge (A) must be cleaned every month and replaced every 18 months.
2. The ProClarity Depth filter (B) must be replaced every 3 months.
3. The ProClarity filter canister (C) can be rinsed when the filters are cleaned.
4. The ProClear II skimming filter cartridge (D) must be cleaned every month and replaced every 18 months.
5. The ProClarity debris bag (E) should be checked and emptied monthly.

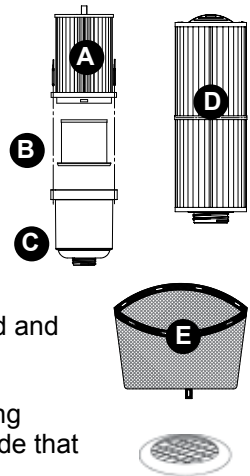

To accomplish this, refer to the following filter cleaning procedure. The circulation pump filter goes on the side that has the wall fitting with the grids, Figure 13.1b.

Note: Do not attempt to wash the ProClarity depth filter (B) and the ProClear/ProClarity debris bag (E) or it will come apart!

J-400 Export

B. Cleaning the Filters/Debris bag:

A **DANGER:** TURN POWER TO SPA OFF! TO DECREASE RISK OF DEATH, DROWNING, OR ENTRAPMENT, NEVER OPERATE SPA WHEN FILTER IS NOT PROPERLY INSTALLED OR IF SKIMMER ASSEMBLY IS DAMAGED OR ALTERED!

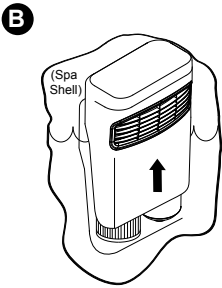

Lift the cover upward to access filter cartridges.

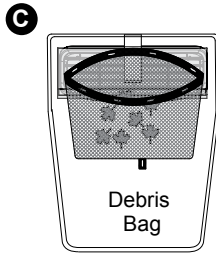

Remove the ProClarity debris bag from clips and then clean out debris.

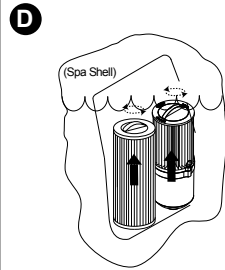

Rotate each filter cartridge handle counterclockwise to unthread from mating wall fitting.

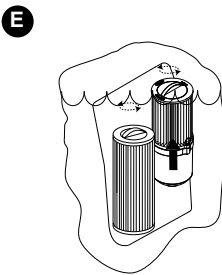

Lift unthreaded filter cartridge from skimmer well.

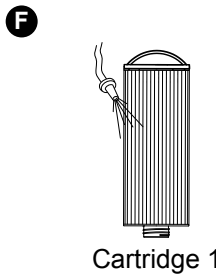

If used, remove the chemical feeder as instructed prior to rinsing the filter cartridge. Rinse debris from filter pleats using a garden hose and high-pressure nozzle. Start at the top and work downward towards handle. Repeat until all pleats are clean.

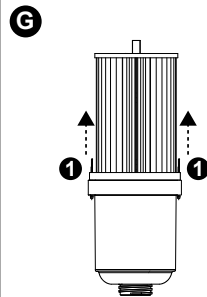

Remove the filter pins **1** in order to separate the ProClarity filter and canister.

H

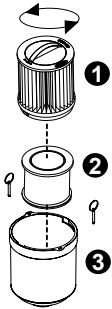

Once the filter pins are removed, rotate the filter cartridge handle counterclockwise to unthread from the filter canister. You can clean the filter **1** and canister **3**, but you must replace the ProClarity Depth Filter **2** every 3 months.

I

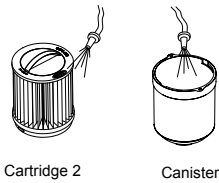

Rinse debris from filter pleats using a garden hose and high-pressure nozzle. Start at the top and work downward towards handle. Repeat until all pleats are clean. Rinse out any debris from the canister.

J

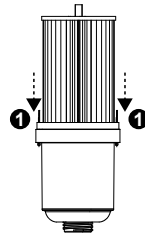

Reassemble the ProClarity Filter. Remember to replace the depth filter with a new one. Once the filter is assembled, secure it with the filter pins **1**.

K

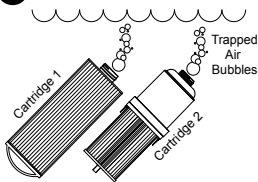

Submerge both filter cartridges in spa. Tilt threaded end upward to remove trapped air bubbles, then keep cartridges submerged to prevent air entrapment during installation.

L

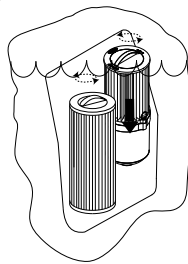

Place each cartridge back into skimmer well, then rotated each cartridge handle clockwise to thread back into wall fitting. **DO NOT OVERTIGHTEN!**

M

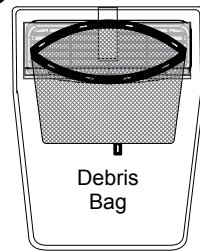

Install clean debris bag back onto the filter cover clips as shown (you can flip the filter skimmer and use the back side to extend usage).

J-400 Export

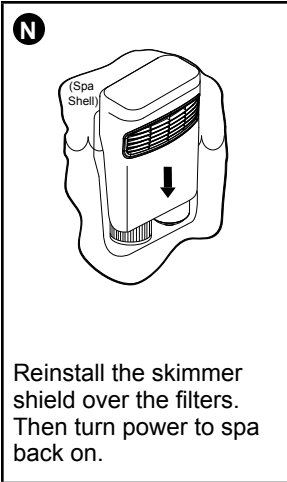

13.2 Draining and Refilling

About every 3 months, you will want to replace the spa's water. The frequency depends on a number of variables including the amount of use, number of users, attention paid to water quality maintenance, etc. During this time, it is also recommended that you use Jacuzzi's Jet Line Cleaner to clean the internal plumbing lines from buildup and debris.

Note: Jacuzzi chemicals are for use in the U.S. only.

CAUTION! READ THIS BEFORE DRAINING: To prevent damage to the spas components, turn off power to the spa at the circuit breaker before draining it. Do not turn the power back on until your spa has been refilled.

CAUTION: There are certain precautions to keep in mind when draining your spa. If it is extremely cold, and the spa is outdoors, freezing could occur in the lines or the equipment (see "WINTERIZING," page 65). On the other hand, if it is hot outdoors, do not leave the spa's surface exposed to direct sunlight.

A. To drain your spa, perform the following steps (standard drain):

1. Turn off power to spa at breaker.
2. Locate the drain valve located on the front left corner on the black plastic pan. Hold the larger (rear) drain valve body to prevent it from turning, then loosen and remove the front cap to expose the underlying male hose threads, Figure 13.2a.
3. Attach a garden hose to the exposed threads, Figure 13.2b.

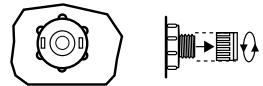

Figure 13.2a

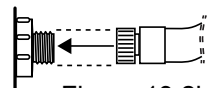

Figure 13.2b

4. Gently rotate the larger (rear) valve body 1/3 turn counterclockwise to unlock the drain valve, Figure 13.2c.
5. Pull the larger (rear) body outward as shown to open drain, Figure 13.2d.
6. After the spa drains, perform steps 2-5 in reverse order to close the drain prior to refilling spa.



Figure 13.2c

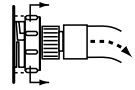

Figure 13.2d

After refilling, turn on power to the spa and follow the steps listed under “Spa Fill Up Procedures” (page 18). Always fill your spa through both filter buckets.

B. To drain your spa, perform the following steps (QuickDrain):

1. Turn off power to hot tub at the breaker.
2. Locate the door’s retractable push button on the top of the front panel, Figure 13.2e.
3. Press the retractable push button to release the panel door from the spa frame, Figure 13.2f.
4. Slowly and gently tilt the panel forward and then lift up to remove, Figure 13.2g. This will expose the equipment bay for easy access to the components. Place the panel in a safe location to prevent from damaging it.
5. Locate the QuickDrain valve, Figure 13.2h.
6. Unscrew drain valve cap, Figure 13.2i. Place the cap aside.
7. Screw in the adapter with hose that was included in the equipment bay; attach it to the QuickDrain, Figure 13.2j. Make sure to direct the hose to an area where the water will drain properly.
8. Open the drain slice valve by sliding the handle to the side and pulling up.

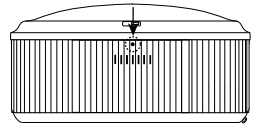

Figure 13.2e



Figure 13.2f

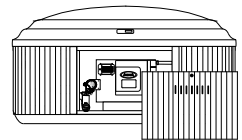

Figure 13.2g

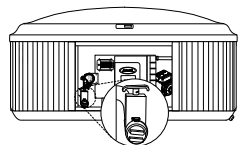

Figure 13.2h

Note: If the QuickDrain is slow, remove the circulation pump filter to ease the flow.

9. After the hot tub has drained close the slice valve by pushing it downward and sliding the handle to the side. Remove the adapter and reinstall the QuickDrain cap before refilling hot tub.
10. To reinstall the panel just follow the steps above in reverse order.

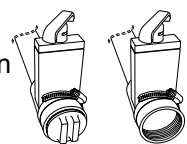

Figure 13.2i

After refilling, turn on power to the spa and follow the steps listed under “Spa Fill Up Procedures” (page 18). Always fill your spa through both filter buckets.

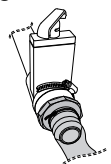

Figure 13.2j

J-400 Export

13.3 Cleaning the Spa Interior

To preserve the sheen of your spa's surface, it is crucial that you avoid using abrasive cleaners or cleaners which have adverse chemical effect on the surface. If you are not certain as to the suitability of a particular cleanser, consult your authorized Jacuzzi dealer. We recommend using Jacuzzi's Spa All Purpose Cleaner to clean the spa's interior surface. Use extreme care to assure that no soap residue is left on the surface. This could cause severe sudsing when the spa is refilled. Jacuzzi chemicals are for use in the U.S. only.

13.4 Pillow Care

Clean the headrests in your spa as needed by wiping them with a cloth with soapy water. It is not necessary to remove the headrests for cleaning. To remove headrests for long term storage or replacement, grasp both ends of each headrest and gently pull inward towards the center of the spa. To reinstall, over mounting strip and press down until headrest mounting bracket emits a "click" sound. Then adjust headrest height by simply moving up or down as desired.

13.5 Maintaining the Synthetic Cabinet

The synthetic cabinet requires little or no maintenance of any kind. To clean, simply wipe cabinet with mild detergent soap solution and a clean towel.



CAUTION: Never spray cabinet with a high pressure garden hose for any reason since this action may induce an electrical short in the spa's electrical equipment.

13.6 Cleaning the Control Panel

To clean, simply wipe control panel with a micro-fiber cloth that is used for cleaning polycarbonate lenses.

13.7 Cover Care and Maintenance

Certain hot tub covers distributed by Jacuzzi Hot Tubs have a vinyl or PROLAST™/PROLAST™ Extreme encasement. This vinyl or PROLAST™/PROLAST™ Extreme encasement also referred to as the cover "skin" is attractive and durable. Regular monthly cleaning and conditioning (vinyl) is strongly recommended and may increase the longevity of your cover. Jacuzzi chemicals are for use in the U.S. only.

A. To clean and condition the encasement (cover skin):

1. Use a garden hose to remove any debris.
2. Using a large sponge or soft bristle brush, use diluted or mild soap to gently scrub the top.
3. Rinse and clean and do not allow soap to dry on the cover. Do not use soap on the underside of the cover.
4. Please check with your Jacuzzi® Hot Tub Dealer for recommended cover care and conditioning products. Use non-petroleum based conditioners to keep the vinyl supple.
5. Do not use any solvents, abrasive cleaners or strong detergents. Do not use products that contain silicone or alcohol.

B. Additional Care and Maintenance Instructions:

1. Debris can accumulate on the spa cover. Removal of snow or other debris will help to avoid breakage of the foam cores.
2. Be sure to lock the cover straps to secure the cover from unwanted or accidental entry.
3. Do not place heavy objects on the cover.
4. Do not walk, sit or stand on the cover.
5. Do not drag or use the flaps/skirt or the cover lock straps to remove the cover.
6. Use only recommended cover lift systems.
7. Use only chemicals and cleaners recommended by Jacuzzi.
8. Remember to keep spa covered when not in use. Maintaining proper water levels assures efficient operation and efficient electrical usage.
9. Do not expose your spa to the sun for extended periods of time as UV rays can damage the interior surface.
10. Use caution when removing cover. Before removing cover, assure all locks have been released to avoid lock breakage and or cover strap damage.

13.8 Winterizing

Your Jacuzzi spa is designed to automatically protect itself against freezing when operating properly. During periods of severe freezing temperatures, you should check periodically to be certain that the electrical supply to the spa has not been interrupted. In extreme, bitter cold weather (less than 32°F) we recommend that the circulation pump is set for 24-Hour operation (Section 12.2 Programming The Primary Filter Cycle, page 45) and that auto-heating is selected (Section 12.1 Auto-Heating, page 48) to protect against damage to the spa.

If you do not intend to use your spa, or if there is a prolonged power outage during periods of severe freezing temperatures, **it is important that all water be removed from the spa and equipment to protect against damage from freezing.**

Expert winterization of your spa is highly recommended; contact your authorized Jacuzzi dealer. In emergency situations, taking the following steps can minimize damage:

CAUTION: TURN OFF POWER TO SPA.
--

1. Follow the directions on page 62 for draining the spa.
2. Turn the massage/diverter selector(s) into the middle combo position to allow the water in the plumbing lines to drain, page 46.
3. Turn the waterfall valve to the open position to allow the water in the plumbing lines to drain, page 46.
4. As the water level drops below the seats, use whatever means necessary to get the water out of the recessed seating areas and into the footwell, such as a wet/dry vacuum.

J-400 Export

5. Open all the air controls and leave them open until you resume use of the spa, page 46.
6. When the water level ceases to drop, use whatever means available to remove any remaining water from the footwell, such as a wet/dry vacuum.
7. Remove the equipment-side cabinet panels and locate the drain plugs in the front of each pump (Figure A, page 14). Remove these plugs to allow the water to drain out of the pumps and heater.
Note: Approximately one to two gallons will be released during this procedure. Use a wet/dry vacuum or other means to keep this from flooding the equipment compartment. Replace the drain plugs.
8. Loosen hose clamp at bottom of heater (Figure A, page 14) and pull hose off of heater fitting (twist the hose back and forth while pulling downward). Tip hose down and allow it to drain and then reinstall hose and clamp.
9. Loosen the hose clamp on the circulation pump (if equipped) intake behind the control box (Figure A, page 14) and pull the hose off (twist hose back and forth while pulling outward). Tip hose down and allow it to drain and then reinstall hose and clamp.
10. Loosen hose clamp at bottom of CLEARRAY® system and pull hose off of CLEARRAY fitting (twist the hose back and forth while pulling downward). Tip hose down and allow to drain. Then reinstall hose and clamp. Remove the cover of the CLEARRAY system to access the UV bulb and quartz tube. Remove and store the UV bulb in a safe location. Remove and dry off the quartz tube then reinstall it. Depending on the length of time, consider replacing the UV bulb when you resume use of your hot tub.
11. Re-install cabinet side panels and cover spa so that no casual moisture can enter into it.

Consult your Jacuzzi dealer if you have any questions regarding winter use or winterizing.

13.9 Restarting Your Spa in Cold Weather

If you want to start up your spa after it has sat empty for a time in freezing temperatures, be aware that the water remaining in certain Sections of the piping may still be frozen. This situation will block water flow preventing the spa from operating properly and possibly damaging the equipment. We recommend you consult your dealer for guidance before attempting to restart your spa under these conditions.

14.0 Water Quality Maintenance

To decrease the risk of contracting a waterborne illness (e.g. an infection, bacteria or virus) and/or respiratory ailments, maintain water quality within specified limits. This will enhance your enjoyment and prolong the life of the hot tub's equipment. Doing so requires regular attention because the water chemistry involved is a balance of several factors. Procrastination in regard to water maintenance will result in poor and potentially unhealthful conditions for soaking and even damage to your hot tub investment. For specific guidance, on maintaining water quality, consult your authorized Jacuzzi dealer who can recommend the appropriate Jacuzzi chemical products. Jacuzzi chemicals are for use in the U.S. only.



WARNING: FAILURE TO MAINTAIN WATER QUALITY WILL:

- Increase risk of contracting a waterborne illness (e.g. an infection bacteria or virus) and/or respiratory ailments.
- Damage the equipment, components and spa shell, which are not covered under the hot tub's warranty.

CAUTION: Never store hot tub chemicals inside the hot tub's equipment bay. The equipment bay may reach elevated temperatures, this is where high voltage electronic devices are located. This area is not intended for storage of any kind.

14.1 pH Control

pH is a measure of relative acidity or alkalinity of water and is measured on a scale of 0 to 14. The midpoint of 7 is said to be neutral, above which is alkaline and below which is acidic. In spa water, it is very important to maintain a slightly alkaline condition of 7.4 to 7.6. Problems become proportionately severe the further outside of this range the water gets. A low pH will be corrosive to metals in the spa equipment. A high pH will cause minerals to deposit on the interior surface (scaling). In addition, the ability of the sanitation agents to keep the spa clean is severely affected as the pH moves beyond the ideal range. That is why almost all spa water test kits contain a measure for pH as well as sanitizer. Jacuzzi offers products that help you maintain the ideal range. These chemicals are for use in the U.S. only.

14.2 Sanitizing

To destroy bacteria and organic compounds in the spa water, a sanitizer must be used regularly. Chlorine and bromine are the two most popular sanitizers used to date. The "Proclear Mineral Spa Clarifier" designed especially for your hot tub is a beneficial product for water maintenance. Many other additives are available for your spa. Some are necessary to compensate for out-of-balance water; some aid in cosmetic water treatment and others simply alter the feel or smell of the water. Your authorized Jacuzzi dealer can advise you on the use of these additives. When adding spa shock (chlorine

J-400 Export

or non-chlorine) or pH balancing chemicals activate the jet pump(s) and leave the spa cover open for a minimum of 20 minutes. By doing this you will allow excessive chemical vapors to exit the spa, protecting pillows and plastic knobs from chemical attack.



WARNING: RISK OF PERSONAL INJURY, DROWNING OR ENTRAPMENT!

Never leave your hot tub unattended for any reason while the cover is open and accessible, especially to small children and animals!

CAUTION: RISK OF PERSONAL INJURY OR SPA DAMAGE!

Never add chlorine tablets (trichlor) or acid to your hot tub for any reason! These chemicals may damage components within your hot tub, burn or irritate your skin, create a rash and void the manufacturer warranty for your spa.

14.3 Other Additives

Many other additives are available for your spa. Some are necessary to compensate for out-of-balance water, some aid in cosmetic water treatment and others simply alter the feel or smell of the water. With our chemical products your authorized Jacuzzi dealer can advise you on the use of these additives. Jacuzzi chemicals are for use in the U.S. only.

14.4 CLEARRAY® (Ultraviolet) Water Purification System

CLEARRAY Water Purification System is exclusive technology utilizing natural ultraviolet technology to eliminate waterborne bacteria, viruses, and algae in portable spas. The ultraviolet light otherwise known as UV-C or germicidal light inactivates the microorganisms disrupting the DNA so that it cannot reproduce and is considered lifeless. CLEARRAY is plumbed in-line with your filtration system. After the water is drawn from the pump, filter, and heater it is then directed through the CLEARRAY system. Water passes through an ultraviolet light energy that treats and disinfects the water. The water is then pumped back into the spa giving you crystal clear water instantly. The system has a ballast that is the power supply for the purification system (Figure 14.4a); it has two LED indicator lights. The "Power On" (red color) indicating incoming power flow and the "Lamp on" (green color) indicating the system is properly working. CLEARRAY is standard for all models.

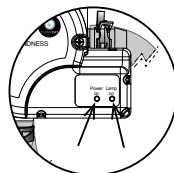

Figure 14.4a

After a year the bulb must be replaced. If the CLEARRAY timer has been programmed correctly a message will appear on the LCD display when the time allotted has expired. In order to clear the message, a new CLEARRAY UV bulb needs to be installed and the timer must be reset, page 51.



WARNINGS:

- Do not operate the UV-C emitter when it is removed from the appliance enclosure.
- This appliance contains a UV-C emitter.
- Unintended use of the appliance or damage to the housing may result in the escape of dangerous UV-C radiation. UV-C radiation may, even in little doses, cause harm to the eyes and skin.
- Appliances that are obviously damaged must not be operated.
- Read the maintenance instructions before opening the appliance.

14.5 CLEARRAY® Bulb Replacement and Quartz Tube Maintenance

Important: It is **MANDATORY** that the CLEARRAY UV bulb is replaced and the quartz tube be cleaned every 12 months to maintain optimum performance.

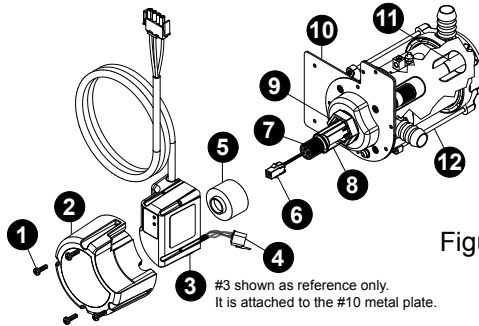

Figure 14.5a



DANGER: TURN THE SPA BREAKER TO THE OFF POSITION!



WARNING: DRAIN THE SPA IF YOU ARE REPLACING OR CLEANING THE QUARTZ TUBE!



WARNING: ALLOW BULB TO COOL DOWN PRIOR TO REMOVING FROM QUARTZ TUBE.



DANGER: NEVER LOOK AT THE LIT BULB. THIS CAN CAUSE SEVERE EYE DAMAGE OR BLINDNESS.

UV bulb replacement and quartz tube maintenance:

Note: Location of CLEARRAY System and connection may vary by model.

1. Turn the breaker to the spa OFF. DRAIN YOUR SPA.

Note: If you are only replacing the UV bulb then the spa does not have to be drained. You will need to drain it if you are replacing or cleaning the quartz tube.

J-400 Export

2. Once the UV bulb has cooled off remove the CLEARRAY System enclosure cover (2) by removing the four screws (1). This will expose the UV bulb and connections, Figure 14.5b.

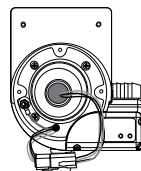

Figure 14.5b



DANGER: NEVER REMOVE COVER WITHOUT FIRST TURNING OFF AT POWER SOURCE AND DRAINING THE SPA.

Figure 14.5c

Figure 14.5d

Figure 14.5e

Figure 14.5f

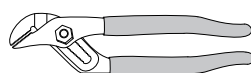
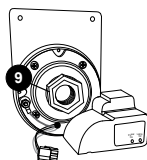
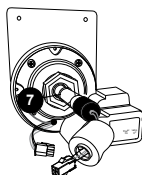
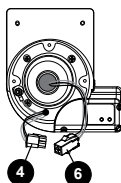

3. Disconnect UV bulb socket (6) from the power cord socket (4), Figure 14.5c.
4. Slowly remove the UV bulb (7) out of the quartz tube, Figure 14.5d.
5. Remove the quartz seal compression nut (9) by turning it **counterclockwise**, Figure 14.5e. Use a pair of channel-lock pliers if needed, Figure 14.5f.
6. Now you are ready to clean or replace the quartz tube (8). For cleaning the quartz tube, follow steps 7 and 8 then proceed from step 9. For replacing quartz tube, skip steps 7 and 8 and proceed from step 9.
7. **Cleaning quartz tube:** Clean the quartz tube by wiping, until clear, using a paper towel or a dry cotton cloth. If needed, a household tub and shower lime removal product can be used.



WARNING: Do not use abrasive cleaners as they can scratch the quartz tube surface.

8. Rinse the quartz tube with clean water to completely remove any cleaning products that were used in step 7.
9. **Replacing quartz tube:** Remove the black o-ring from the quartz tube and place it on the new tube. Place the new quartz tube (8) into the water chamber (12) with the domed end first making sure it is inserted and seated inside the quartz end holder (11).
10. Reinstall and hand tighten the quartz seal compression nut (9) by turning it **clockwise**.
11. Refill your spa.
12. **System Test 1:** Assure there is no water dripping from the seal compression nut (9). If water is visible, STOP and tighten the compression nut (9) using a pair of channel lock pliers to a maximum of 1/4 turn. If that does not fix the leak, then repeat quartz tube maintenance process from step 1 through step 11. Make sure there is no water leaking before proceeding to step 13.

- System Test 2:** Reconnect the CLEARRAY unit to the controller. Turn breaker back ON. Turn on the pump to circulate the water through the CLEARRAY System. Wait for 5 minutes and assure no water is dripping. If water is visible, STOP, fix the leak by repeating quartz tube maintenance process from step 1 through step 12. **Make sure there is no water visible. Turn the pump and breaker OFF BEFORE proceeding to step 14.**
- Reconnect the UV bulb socket (6) to the power cord socket (4) make sure you use the latex glove provided when handling the UV bulb.



WARNING: DO NOT TOUCH THE NEW UV BULB WITH YOUR BARE HAND. Oil on your skin will cause hot spot on the UV bulb and shorten the life of your UV bulb. Use the provided latex glove to handle the UV bulb.

- Slide the new UV bulb (7) back inside the quartz tube.
- Reinstall the black bulb boot (5) back over the quartz seal compression nut (9).
- Reinstall the enclosure cover (2) and secure with the screws.
- Properly dispose of the old UV bulb.



WARNING: This CLEARRAY System includes a UV bulb, which contains mercury. Dispose of the bulb in accordance with disposal laws. See www.lamprecycle.org.

- Once power is activated you can check the ballast, Figure 14.5g, to see if the CLEARRAY System is functioning. The power on (red) light indicates that the CLEARRAY System is being provided power and should always be on. The lamp on (green) light indicates that UV bulb is activated.

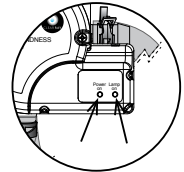



Figure 14.5g

15.0 Error/Display Messages

There are a number of unique functions designed into your Jacuzzi spa to protect it from damage and/or to aid in troubleshooting. When this occurs the spa will notify you by showing the screen below, Figure 15.0a. A solid white light indicates that all operations are normal. A solid red light indicates that immediate attention is required to clear or fix an error code. Following is a listing of all the possible messages along with their meanings. **Always insist on genuine Jacuzzi replacement parts.**



Note: If you tap  the display will change to Figure 15.0b. The error icon  will remain on the screen as a reminder. If the error is not taken care of or fixed, the error display will reappear in 2 hours, Figure 15.0a.

J-400 Export

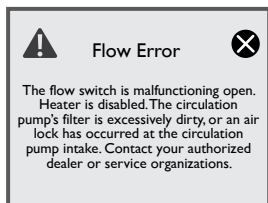



Figure 15.0a



Figure 15.0b

1. Open Flow Switch: (Heater is deactivated. The filter/circulation may also be deactivated.) The flow switch is malfunctioning open, the circulation pump's filter cartridge is excessively dirty or an air lock condition has occurred at the circulation pump intake. Contact your authorized dealer or service organization.
2. Closed Flow Switch: (Heater is deactivated. The filter/circulation may also be deactivated.) The flow switch is malfunctioning closed. Contact your authorized dealer or service organization.
3. Toggleing Flow Switch: (Heater is deactivated.) The flow switch is behaving erratically. Heater is disabled, check for dirty filter. Make sure to clean the filter(s) and correct proper water level before contacting your dealer or service organization.
4. Shorted Hi-limit Temp Sensor: The hi-limit temperature sensor is not functional. Heater is disabled. This must be repaired only by a qualified authorized service organization or service technician.
5. Open Hi-limit Temp Sensor: The hi-limit temperature sensor is not functional. Heater is disabled. This must be repaired only by a qualified authorized service organization or service technician.
6. Shorted Water Temp Sensor: The temperature sensor is not functional. Heater is disabled. This must be repaired only by a qualified authorized service organization or service technician.
7. Open Water Temp Sensor: The temperature sensor is not functional. Heater is disabled. This must be repaired only by a qualified authorized service organization or service technician.
8. Closed Flow Switch on Start-up: Flow switch is non-functional. Closed or shorted flow switch on system start-up (system disabled). Contact your authorized dealer or service organization.
9. Frozen on Start-up: Flow switch is non-functional. Shorted flow switch on system start-up (system disabled) and freeze condition detected. Contact your authorized dealer or service organization.



10. Cool Warning: Spa water is more than 11°C/20°F cooler than the temperature set point, the circulation pump and heater will automatically activate to provide freeze protection. The spa will stay in this mode until the water temperature reaches 8°C/15°F below the set temperature. No corrective action is necessary.

Note: The heater icon  will be blinking and the error icon  will be displayed under the temperature.

11. Freeze protection: A potential freeze condition has been detected. No action is required. Jets pump(s) operate until the spa is out of danger. No corrective action is necessary. If condition persists, contact your authorized dealer or service organization.

12. Overheat protection: **DO NOT ENTER THE WATER!** Water temperature is above acceptable limits. Heater is deactivated. Remove spa cover to speed cooling. If condition persists, contact your authorized dealer or service organization.



Note:

- As a safety measure, the red lights of the spa will flash on and off as an indication that the spa is an overheat condition.
- The heater icon  will be blinking and the error icon  will be displayed under the temperature.



**WARNING: RISK OF HYPERTHERMIA (OVER-HEATING)
CAUSING SEVERE INJURY, BURNS, OR WELTS.**



13. Watchdog Protection: **DO NOT ENTER SPA!** Water temperature is above acceptable limits. Your spa is deactivated. Remove spa cover to speed cooling. If condition persists, contact your authorized dealer or service organization.

Note: The heater icon  will be blinking and the error icon  will be displayed under the temperature.





**WARNING: RISK OF HYPERTHERMIA (OVER-HEATING)
CAUSING SEVERE INJURY, BURNS, OR WELTS.**

14. Watchdog Freeze Protection: Spa water is below 4.4°C/40°F. Jet pumps operate until the spa is out of danger. Contact your authorized dealer or service organization.

Note: The heater icon  will be blinking and the error icon  will be displayed under the temperature.

15. Controller Overheat Protection: Controller temperature has exceeded acceptable limits. If condition persists, provide shade for equipment side of spa. Contact your authorized dealer or service organization.

Note: The heater icon  will be blinking and the error icon  will be displayed under the temperature.

J-400 Export

16. Panel Com Error: The topside controller is having trouble communicating to your spa. Contact your authorized dealer or service organization.
17. Stereo Com Error: The stereo is having trouble communicating to your spa. Contact your authorized dealer or service organization.
18. Wi-Fi Com Error: The Wi-Fi module is having trouble communicating to your spa. Contact your authorized dealer or service organization.

19. CLEARRAY Replacement Reminder: This message will appear when the CLEARRAY bulb reminder time has expired (Figure 15.0c). The CLEARRAY bulb must be replaced.

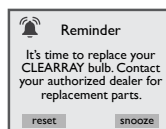

Figure 15.0c

20. ProClarity/ProClear Filter Reminder: This message will appear when the filter reminder time has expired (Figure 15.0d). Remove the ProClarity/Proclear filters and filter/debris bag for cleaning or replacement.

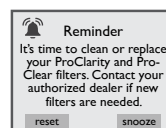

Figure 15.0d

21. ProClarity Depth Filter Reminder: This message will appear when the filter reminder time has expired (Figure 15.0e). The ProClarity Depth filter must be replaced.

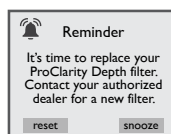

Figure 15.0e

22. Water Refresh Reminder: This message will appear when the "Water Refresh" timer has expired (Figure 15.0f). The water needs to be drained and refilled with fresh water.

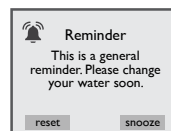



Figure 15.0f

23. Extended Temperature Activated: The spa is set to go up to 40°C (104°F), but it can be set to reach 41°C (106°F). To access the extended temperature you need press and hold your finger over the temperature reading for about 5 seconds. The temperature reading will start to blink to indicate the system is ready. Tap  to raise the temperature up to 41°C (106°F).

Note: The heater icon  will be blinking to indicate that the feature is active.



WARNING: RISK OF HYPERTHERMIA (OVER-HEATING) CAUSING SEVERE INJURY, BURNS, WELTS OR DEATH!

Water temperature in excess of 40°C (104°F) may be injurious to your health.

16.0 Troubleshooting Procedures

In the unlikely event your spa is not working the way you believe it should, please first review all the installation and operating instructions in this manual and check the message on the panel display; second, if you are still not satisfied it is working properly, please follow the appropriate troubleshooting instructions.

PROBLEM

PROCEDURE

NONE OF THE COMPONENTS OPERATE (i.e. pump light)

Check the control panel lights.

1. If there are letters or symbols displayed on the screen, refer to the previous Section 15.0 to determine the meaning and action required.
2. If nothing appears on the screen:
 - A. Check the household circuit breaker.
 - B. Contact you dealer or authorized service center.

PUMP DOES NOT OPERATE

Activate the "JETS":

1. If no sound is detected or if a "buzzing" sound is detected, turn off power to the spa and contact your dealer or service center.
2. If motor operates but no water flows to jets:
 - A. Pump may not be properly primed. See instructions below.
 - B. Contact dealer or authorized service center.

Pump Priming Instructions:

1. Turn off power to the spa.
2. Remove the handle from the massage selector supplied by the pump you are priming.
3. Loosen the massage selector's cap slightly (counterclockwise), listening for the air to seep out.
4. Tighten the cap finger-tight, replace the handle and turn the hot tub's power back on.

Note: This method must be used for the jet's pumps because these pumps are not connected to the main filter system in any way.

CAUTION: If freezing conditions exist and pump is not operational, take measures to protect the system from freeze damage. See Section 13.8 titled "Winterizing" (page 65).

J-400 Export

- POOR JET ACTION
1. Make certain the jets pump is turned on.
 2. Check position of massage selectors.
 3. Open air control for selected jet system.
 4. Check for adequate water level.
 5. Check for dirty filter (page 59).

- WATER IS TOO HOT
1. Reduce thermostat setting.
 2. Switch hot tub to “Econo” mode to turn heater on only during pre-programmed time (page 48).
 3. Make sure the pumps are turned off and not constantly running.

- NO HEAT
1. Check thermostat setting.
 2. Keep the cover in place while heating.
 3. If heater indicator is displayed, but no temperature increase is experienced after a reasonable period of time, contact your dealer or authorized service center.

- FILTER/CIRCULATION PUMP OFF
1. Verify filter/circulation pump is programmed to run 8 hours a day (page 45).
 2. Make sure there are no errors preventing the pump from turning on.
 3. Hot tub water is warmer than 34°C (95°F) and two degrees warmer than the set temperature. The “Summer Logic” safety feature has activated. See note on page 50 for details.

Jacuzzi builds the best spas in the industry. Nonetheless, we are always striving to improve the quality and features of our products. Your input as a Jacuzzi spa owner is a cherished part of this process. If you have any comments or suggestions, or if you wish to be informed on any new products for your spa, please write to us.

CONGRATULATIONS on your good taste and welcome to the happiest and most relaxed family in the world!

17.0 Circuit Board Wiring Diagrams

17.1 J415/J425/J470/J480 Export 50Hz Wiring Diagram

Single service connection is the factory default.

NOTE: For a single service connection use TB1 locations B and C. Additionally, the extra White wire **must** be installed.

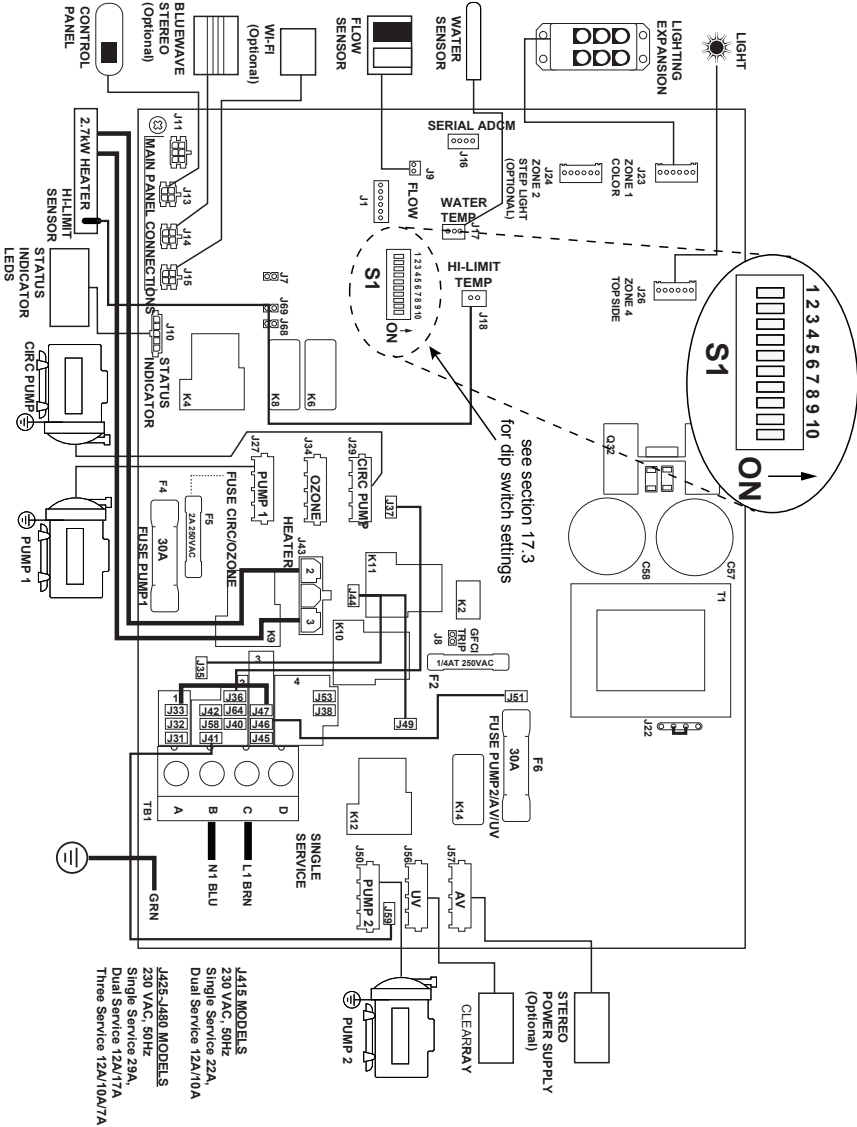

J-400 Export

17.2 J495 Export 50Hz Wiring Diagram

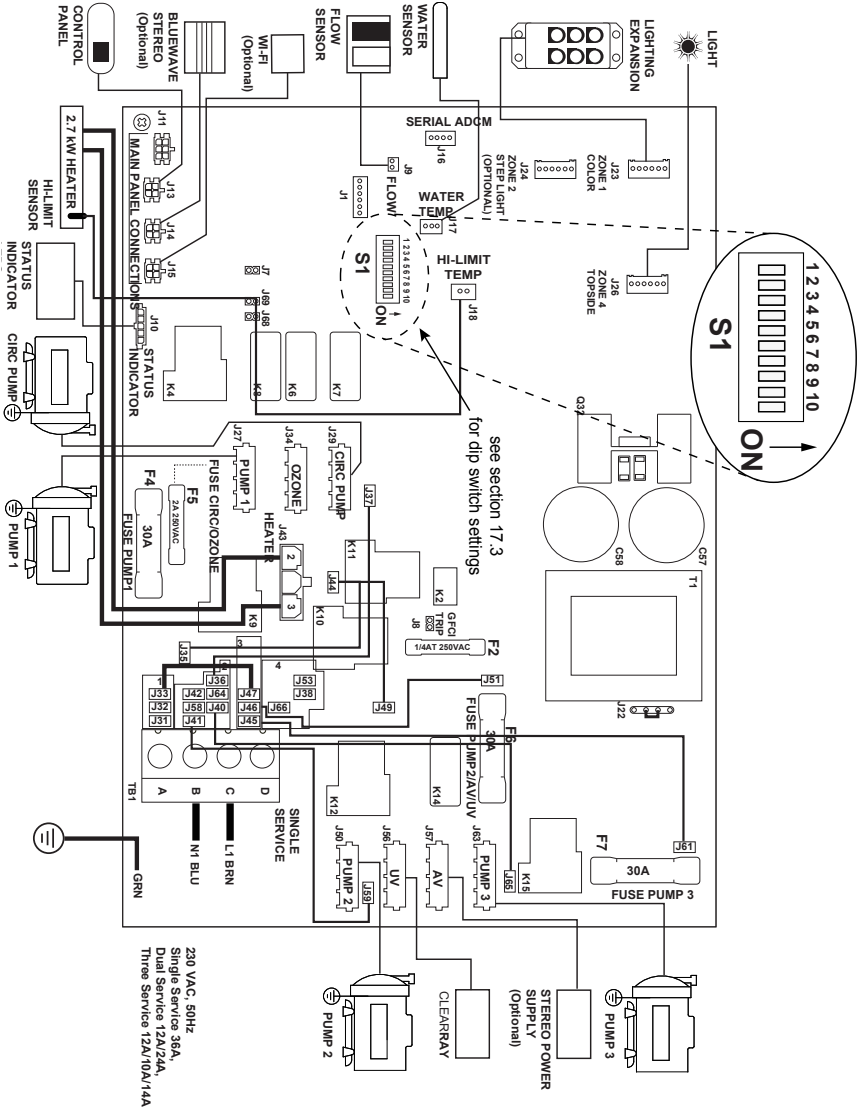

17.3 Dip Switch Settings

A. 1 or 2 pump models

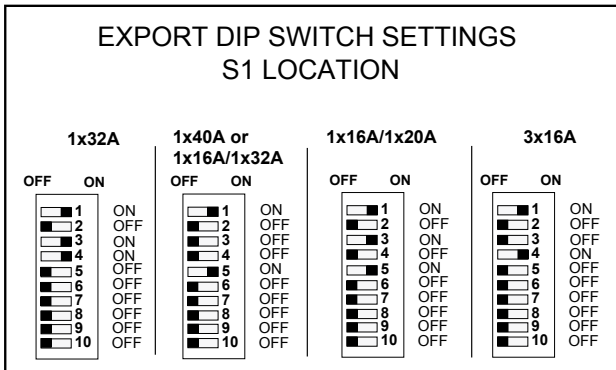
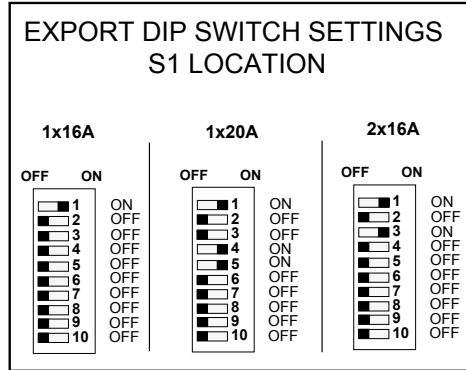

BREAKER	DIP SWITCH NUMBER									
	1	2	3	4	5	6	7	8	9	10
1x16A	ON	OFF	OFF	OFF	OFF	OFF	OFF	OFF	OFF	OFF
1x20A	ON	OFF	OFF	ON	ON	OFF	OFF	OFF	OFF	OFF
2x16A	ON	OFF	ON	OFF	OFF	OFF	OFF	OFF	OFF	OFF
1x32A	ON	OFF	ON	ON	OFF	OFF	OFF	OFF	OFF	OFF
1x40A or 1x16A/1x32A	ON	OFF	OFF	OFF	ON	OFF	OFF	OFF	OFF	OFF
1x16A/1x20A	ON	OFF	ON	OFF	ON	OFF	OFF	OFF	OFF	OFF
3x16A	ON	OFF	OFF	ON	OFF	OFF	OFF	OFF	OFF	OFF

J-400 Export

B. 3 pump models

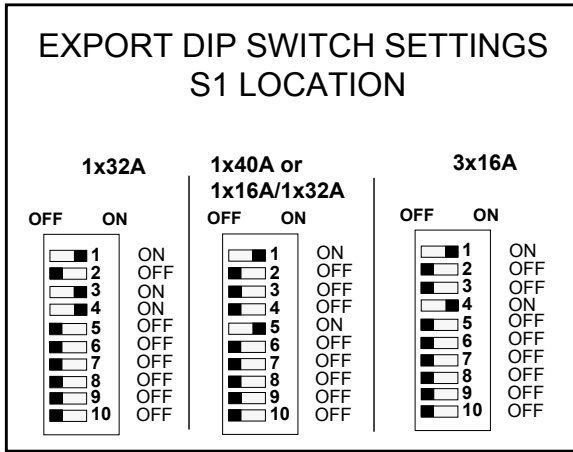

BREAKER	DIP SWITCH NUMBER									
	1	2	3	4	5	6	7	8	9	10
1x32A	ON	OFF	ON	ON	OFF	OFF	OFF	OFF	OFF	OFF
1x40A or 1x16A/1x32A	ON	OFF	OFF	OFF	ON	OFF	OFF	OFF	OFF	OFF
3x16A	ON	OFF	OFF	ON	OFF	OFF	OFF	OFF	OFF	OFF

C. Configuration settings for J415-J480 Models

Single Service (default setting):

- 1x16A **(J415 Only)** This setting will turn the heater off any time the jets pump is activated.
- 1x20A This setting will turn the heater off any time either one of the pumps are activated on two pump models.
- 1x32A This setting is for all two pump model spas. Both pumps and the heater will be allowed to operate at the same time.

Dual Service:

- 2x16A **(J415 Only)** Both the jets pump and the heater will be allowed to operate at the same time.
- 1x16A/1x20A This setting is for all two pump model spas. Both pumps and the heater will be allowed to operate at the same time.

Three Phase Service:

- 3x16A This setting is for all two pump model spas. Both pumps and the heater will be allowed to operate at the same time.

D. Configuration settings for J495 Models

Single Service (default setting):

- 1x32A This setting will allow the heater to operate when two jets pumps are activated. If all three pumps are activated the heater will shut off.
- 1x40A All three jets pumps and the heater will be allowed to operate at the same time.

Dual Service:

- 1x16A/1x32A All three jets pumps and the heater will be allowed to operate at the same time.

Three Phase Service:

- 3x16A All three jets pumps and the heater will be allowed to operate at the same time.

J-400 Export

17.4 Single Service 50Hz Connection

Wiring for export models with a single service breaker. The jumper wiring is shown below. The included extra White wire (1*) **must** be installed.

This is the factory default.

J415/J425/J470/J480 Single Service Jumper Wiring		
Wire	From	To
1*	J33	J47
2	J37	J36
3	J46	J51
4	J59	J41
*Install extra white wire at these jumpers		

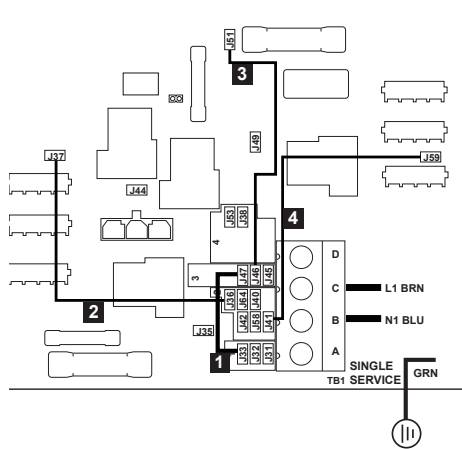

BREAKER TERMINAL CONNECTIONS

L1 = All Components

J495 Single Service Jumper Wiring		
Wire	From	To
1*	J33	J47
2	J37	J36
3	J45	J61
4	J46	J51
5	J59	J41
6	J65	J40
*Install extra white wire at these jumpers		

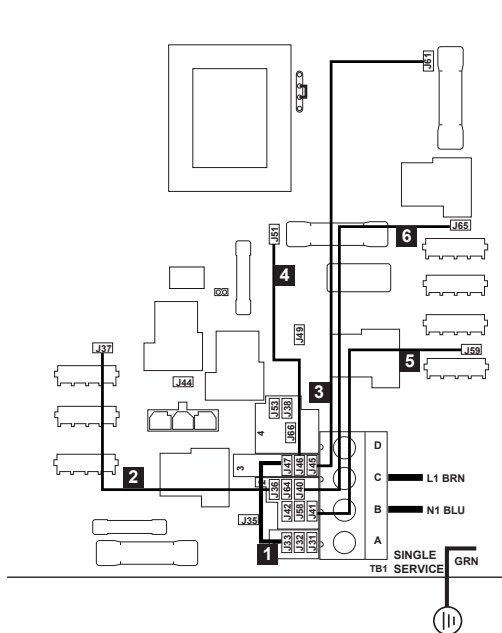

BREAKER TERMINAL CONNECTIONS

L1 = All components

17.5 Dual Service 50Hz Connection

Wiring for export models with dual service breakers. The jumper wiring is shown below.

J415/J425/J470/J480 Two Service Jumper Wiring		
Wire	From	To
1	J33	J51
2	J37	J53
3	J59	J38

BREAKER TERMINAL CONNECTIONS

L1 = Heater and transformer
L2 = All other components

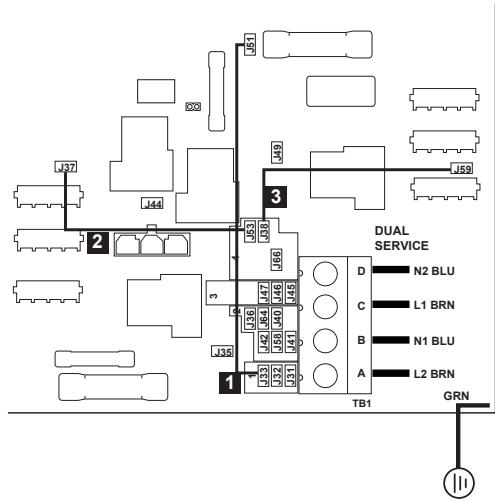

J495 Two Service Jumper Wiring		
Wire	From	To
1	J33	J51
2	J37	J53
3	J59	J38
4	J61	J32
5	J66	J65

BREAKER TERMINAL CONNECTIONS

L1 = Heater and transformer
L2 = All other components

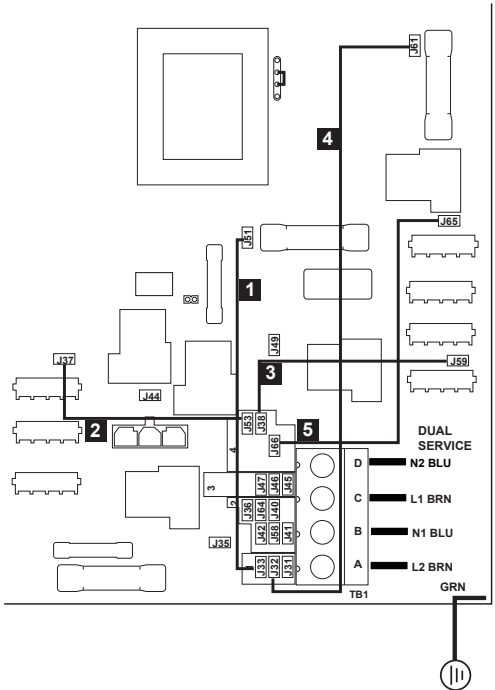

J-400 Export

17.6 Three Service 50Hz Connection

Wiring for export models with three service breakers. The jumper wiring is shown below.

J425/J470/J480 Three Service Jumper Wiring		
Wire	From	To
1	J37	J36
2	J53	J51
3	J59	J41

BREAKER TERMINAL CONNECTIONS

- L1 = Heater and transformer
- L2 = Pump 1 and other components
- L3 = Pump 2

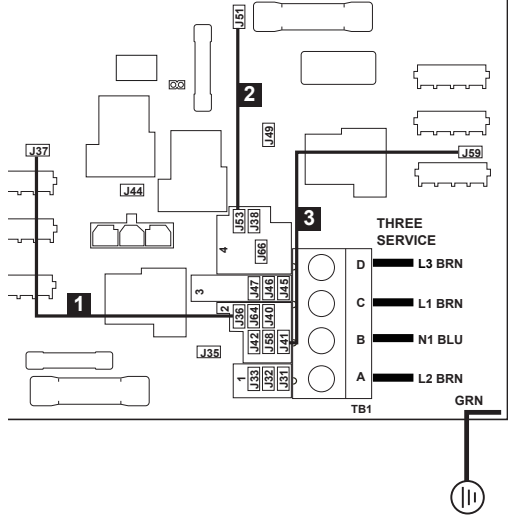

J495 Three Service Jumper Wiring		
Wire	From	To
1	J37	J36
2	J53	J51
3	J59	J41
4	J61	J38
5	J65	J40

BREAKER TERMINAL CONNECTIONS

- L1 = Heater and transformer
- L2 = Pump 1 and other components
- L3 = Pump 2 and Pump 3

